

Designing Schools in New Zealand

Weathertightness Design Requirements for New School Buildings

For Architects and Designers



Version 3.0. September 2020

Document History

The table below is a record of the changes that have been made to this document:

Revision date	Version	Description
April 2011	1.0	Document issued as 'Weather-tightness requirements for schools'
June & August 2014	2.0	Document issued as ' <i>Weather-tightness and Durability Requirements for School Property</i> '
September 2020	3.0	Updates include: <ul style="list-style-type: none">• Document title changed to '<i>Weathertightness Design Requirements for New School Buildings</i>'• Document focussed towards design requirements, with procedural project review processes, roles and responsibilities removed• Previous categories of 'restricted' and 'not permitted' materials and features changed for a single list of 'prohibitions' in each chapter

Foreword

This is an updated version of our previous 2014 *Weather-tightness and Durability Requirements for School Property* document and forms part of a suite of design requirements for school buildings. The updated version should be read alongside the current version of the Ministry's Designing Schools in New Zealand (DSNZ), which is the overarching document for school property design.

Acknowledgement

The Ministry acknowledges the significant contribution of various individuals, groups and organisations who have provided input and feedback for updating this document. This has included architects and designers with considerable experience of designing schools for the Ministry, as well as the Ministry's Construction Quality Control Team, members of the Ministry's Design Review Panel (DRP), Weathertightness Review Panel (WRP) and Weathertightness Strategy Group (WSG).

Feedback and updates

We are seeking to constantly improve the content and usability of our guidelines. If anything in this guideline requires clarification please contact the Ministry through Property.Help@education.govt.nz. Your feedback will help us to ensure this document is maintained as a valuable resource for all of those involved in the design of our schools as effective learning environments.



Kim Shannon

Head of Education Infrastructure Service

Table of Contents

Foreword.....	3
1 Introduction	5
2 Scope of Document	7
3 Summary of Key Requirements	9
4 Surface Water	12
5 Retaining Walls	13
6 Concrete Slab on Grade	14
7 Suspended Timber Floors	22
8 Exterior Wall Structure	24
9 Cladding Systems	26
10 Roof	33
11 Exterior Joinery.....	45
12 Balconies	46
Appendix A: Glossary & References	49

1 Introduction

1.1 Background

This document provides designers for the Ministry of Education's (Ministry's) school building projects with weathertightness requirements for the design of the external envelope of new school buildings.

The Ministry is a long-term asset owner of more than 18,000 school buildings and therefore has a strong interest in optimising the total cost (capital and ongoing maintenance) over the lifetimes of the buildings.

The Ministry has been through a period where many school buildings have suffered external envelope weathertightness failures resulting in damage and at times, health and safety concerns. There have been corresponding significant costs to remediate these buildings which in some cases have needed to be replaced.

The key areas of concern from this experience can be broken down under three headings with the following selected examples:

(a) Building Features or Elements

- Overly complex roof forms (e.g. butterfly and curved roofs)
- Inadequate slope to flat or low-pitched roofs
- Debonding of laps, terminations/edges and junctions with scuppers or rainwater heads of single layer membrane roofs
- Internal gutters with inadequate cross-sectional area and fall, lacking overflows or proper scuppers, and/or with undersized scuppers, rainwater heads and downpipes
- Overly complex building forms (e.g. complex wall and roof junctions, complex floor plan shapes including non-square corners and curved walls)
- Overly complex building elements (e.g. more than two types of wall cladding systems and non-standard shaped exterior joinery such as raking sills or jambs and round windows etc.)
- Proprietary cladding systems with little in-service history in New Zealand
- Cladding systems that are not sufficiently durable
- Sheet cladding systems that are open jointed or with inadequate horizontal 'z' flashings
- Inadequate clearance to base of cladding systems
- Incorrect design and use of threshold channels and nibs
- Poor building underlay installation and/or performance
- Wall and roof cladding penetrations poorly formed and insufficiently detailed, lacking flashings and/or inappropriate use of sealants, with roof penetrations created by roof-mounted plant a particular problem
- Reliance on sealants rather than mechanical flashings, especially for roof and apron flashings
- Poorly installed joinery flashings (head, jamb and sill).

(b) Procedural

- Design requirements not being adhered to
- Design concepts and/or material selection not appropriate
- Insufficient or inadequate levels of documentation
- Unsatisfactory specific design rather than using New Zealand Building Code (NZBC) Acceptable Solutions E2/AS1 or tested and appraised manufacturer details where available
- Construction teams not following contract documentation or trade literature
- Poor quality and defective construction
- Inappropriate design changes during construction.

(c) Maintenance

- Designed details or selected materials and systems which have maintenance requirements that are too onerous in some way (e.g. high cost, poor durability, excessive frequency of cleaning, difficulties implementing due to inspection or access issues or requirements for specialist skills)
- Maintenance not being able to be carried out due to health and safety considerations
- Hidden failure, where building features or elements have detailing such that deterioration or failure is not readily observable to facilitate preventative maintenance
- Lack of maintenance documentation being provided when buildings are handed over
- Inadequate maintenance being undertaken

2 Scope of Document

2.1 Building and Project Types

To avoid future weathertightness and maintenance issues arising with school buildings these requirements apply to new state school buildings as well as extensions and additions that:

- 2.1.1 Create or increase building footprints, and
- 2.1.2 Are up to 3 storeys with a height measured from lowest ground level adjacent to the building to the highest point of the roof (except for flues, aerials and the like) of 10m or less.

In addition to the above:

- 2.1.3 The requirements are applicable to projects that involve 'end-of-life' replacement or the alteration of roof or wall cladding envelopes to existing buildings.

2.2 Exclusions

The requirements in this document do not address or apply to:

- 2.2.1 Procedural processes associated with exemptions, procurement, design, documentation, construction observation, contract administration, quality assurance and roles and responsibilities of project participants.
- 2.2.2 Buildings requiring specific design envelopes (e.g. commercial scale facades or enclosed swimming pools). These projects require either design or peer review by a suitably qualified and experienced qualified façade engineer and the provision of an accompanying PS1 or PS2 producer statement.
- 2.2.3 Buildings over 3 storeys and taller than 10m in height. Whilst many of the key principles in this document can be applied, these projects require either design or peer review by a suitably qualified and experienced façade engineer and the provision of an accompanying PS1 or PS2 producer statement.
- 2.2.4 Ancillary buildings (i.e. storage sheds, non-integral garages and covered walkways etc.).
- 2.2.5 Internal alterations to existing buildings that do not involve modifying the existing external envelope.
- 2.2.6 Weathertightness remediation projects (excluding end-of-life roof or cladding replacement), which must follow the Ministry's Weathertightness Remediation and Regulatory Strategy. This and other supporting documents are provided on the Ministry's public webpage titled *Weathertightness Remediation* under the following file path: www.education.govt.nz/school/property-and-transport/suppliers/weathertightness-remediation/.

2.3 Drawing Details

Illustrated drawing details are provided throughout this document to help convey design concepts and principles. The drawing details in this document are:

- 2.3.1 Provided as examples only, and may not be sufficiently bespoke for use as construction details.
- 2.3.2 Not to be used or considered as standard details. Design teams are responsible for developing design documentation to suit the specific criteria and requirements of each individual project.

3 Summary of Key Requirements

3.1 Design Principles

Architects and/or designers involved with the design and documentation of school buildings must:

- 3.1.1 Take into account that in some areas, the Ministry's requirements exceed those of the NZBC and Acceptable Solution details (e.g. roof pitches, drained and ventilated wall cavities and cladding durability).
- 3.1.2 Design building envelopes which minimise the number, complexity and irregularity of junctions, minimise the number of junctions between different cladding materials and profiles, and avoid features that will affect the durability of elements or materials.
- 3.1.3 Select envelope materials that are readily available, require limited maintenance, optimise whole-of-life costs and deliver appropriate performance throughout the life of the building.
- 3.1.4 For structural systems, either use non-specific design standards or utilise specific structurally engineered design services, so that the building structural systems and the cladding support framing meet the requirements of the selected cladding systems. In particular, the issue of framing stiffness will need to be considered for taller buildings such as halls, gymnasiums and other large structures.
- 3.1.5 Design for health and safety requirements including providing easy access for maintenance purposes.
- 3.1.6 Mitigate the effect of contaminants such as airborne salts or industrial bi-products that will affect a material's durability.
- 3.1.7 Recognise the need for the school to maintain the envelope, including to help ensure that warranty requirements can be met.

3.2 Required Attributes

The attributes below are required for the building features and elements included within this document.

Materials, installations and construction systems are to be installed in accordance with this document and comply with one or more of the following requirements:

- 3.2.1 Be part of a fully documented specific design and Alternative Solution to NZBC/E2 with an in-service history of satisfactory performance and readily available industry installation knowledge and competence.
- 3.2.2 Have reputable and verifiable proof of compliance with the relevant NZBC Clauses (e.g. E2, B1, B2, C etc.) such as BRANZ Appraisals, CodeMark certificates, NZS4284 test reports or other generally accepted certificates.
- 3.2.3 Be in compliance with NZBC Acceptable Solution E2/AS1 (except where this document requires higher standards).

In addition to the above, materials, installations and construction systems must:

- 3.2.4 Be installed by approved installers/applicators where required by the manufacturer, in accordance with supplier/QA procedures.
- 3.2.5 Be able to be safely installed and maintained (Safety in Design must be factored in to the building design).
- 3.2.6 Prevent vermin from entering framing voids and cavities.

Maintenance requirements for materials, installations and construction systems that make up the exterior envelope assembly must in addition to normal maintenance:

- 3.2.7 Require recoating at intervals of no less than seven years for wall claddings which are not pre-finished and timber joinery.
- 3.2.8 Require first recoating at no less than twenty years for metal and other pre-finished roof and wall claddings, and metal joinery.
- 3.2.9 Be practically and readily manageable by the school maintenance staff or maintenance contractors.
- 3.2.10 Be able to be safely performed (Safety in Design principles must be factored in to the building design for maintenance). This includes safe roof access systems and adequate access for elevated work platforms for façade maintenance on two storey buildings.

3.3 Durability

The Ministry is a long-term owner of school buildings and has a strong interest in optimising the total cost over the lifetime of each building. Therefore, external envelope cladding systems are required to have a serviceable life that, with normal maintenance, will be the life of the building. The Ministry does not want cladding systems that require major remediation or recladding, or will deteriorate from premature corrosion and/or degradation, or require excessive or difficult maintenance within the lifetime of the building.

- 3.3.1 The following factors will affect the long term durability of materials:
 - Proximity to salt-laden atmosphere
 - Industrial atmospheric contaminants
 - Ability of rain to reach and wash contaminants from the surface of metals
 - The characteristics of the material selected
 - Ease and cost of repairs and normal maintenance by school maintenance staff or maintenance contractors
- 3.3.2 As a general principle, weathertightness redundancy and robustness are to be incorporated in such ways as:
 - Heavier gauge metal roofing
 - A drained and ventilated cavity wall
 - Rigid air barrier behind the wall cavity
 - Sub-floor polythene sheeting for suspended floors
 - Cost effective and normal maintenance requirements through specific design

3.3.3 Other specific durability requirements are noted within the following chapters where relevant.

3.3.4 Examples of cladding types that are commonly used in school buildings and suitably durable include, but are not limited to:

- Profiled metal sheeting
- Painted timber weatherboard
- Painted fibre cement weatherboard
- Brick veneer
- Fibre cement board which is part of a complete manufacturer's system which relies on mechanical flashings and not sealant for weathertightness

3.4 Prohibited Items

Materials, installations and construction systems that have been found from experience to not fully satisfy the required attributes and design principles within this document, even though they may satisfy the requirements of the NZBC, are noted at the beginning of each Chapter.

4 Surface Water

4.1 Site Drainage and Overland Flow Paths

This section covers surface water issues at external ground and paving levels, with requirements shown below. Rainwater disposal from roofs of buildings is covered separately under [Section 10](#).

- 4.1.1 For smaller sites having a catchment area of no more than 0.25 hectares and within the Scope Limitations of NZBC E1 / AS1, storm water disposal methods and systems can be designed to the acceptable solution.
- 4.1.2 For all new school sites and works on existing school sites that involve building more than 300m² of gross new footprint, surface water disposal is to be designed or reviewed by a civil engineer experienced in hydraulics and stormwater disposal utilising NZBC E1 / VM1, a recognised standard or other applicable design method.
- 4.1.3 To provide for redundancy when drainage systems become blocked, site levels are to be configured so that stormwater and/or overland flow paths are directed away from buildings to appropriate stormwater drainage systems or areas where the water can be adequately disposed of.
- 4.1.4 In all cases, design teams must consider whether there are any water run-off or ponding issues on the site, and if so document these on a plan and show the extent of inundated areas and relevant constraints and opportunities for mitigating the risk. If the site is prone to flooding, a check of existing site ground levels against flood inundation zones must be undertaken.

5 Retaining Walls

5.1 Prohibited Items

The following materials, installations and construction systems are not to be used:

- Retaining walls which are an integral part of the building, including forming part of the external envelope to a habitable / occupied space

5.2 Retaining Walls as a Separate Structure

Retaining walls are to generally be configured as per [Figure 5-1](#) below, so that:

- 5.2.1 They are separated from the exterior wall of the building by a minimum horizontal distance of 1.5 metres.
- 5.2.2 The ground between the retaining wall and the building is paved with a minimum 1:50 fall away from the building, and with surface water drainage provisions as per [Section 4](#).
- 5.2.3 They have free draining backfill and drainage.
- 5.2.4 Retained ground level at the top of the wall has a minimum 500mm width of cross-fall to surface drainage.

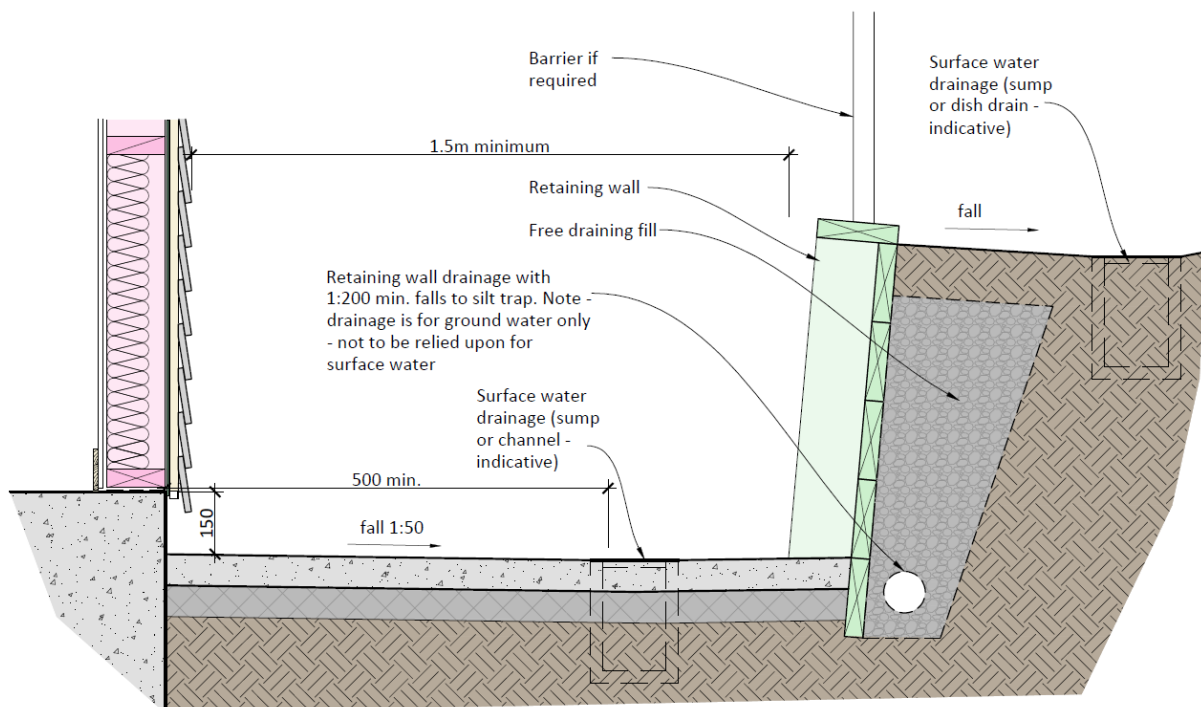

Figure 5-1 Example of Retaining Wall as a Separate Structure

6 Concrete Slab on Grade

6.1 Prohibited Items

The following materials, installations and construction systems are not to be used:

- Nibs formed out of concrete blockwork
- 'U' shaped three-sided proprietary threshold channels that are placed against the slab edge. This is because they do not allow the slab edge to dry out and can cause water to wick up between the slab edge and drain
- Threshold channels at the base of wall cladding, except where they are suitably sheltered as per [Clause 6.3.4](#) below

6.2 Cladding Ground Separation

The following issues must be considered:

- 6.2.1 Where new buildings (and extensions and additions) are constructed with a concrete floor slab, the preference is that the finished floor level should be set above the finished level of adjacent paved ground by a minimum of 150mm (or 100mm for brick veneer) as per E2/AS1 to minimise the need for threshold channels or concrete nibs.
- 6.2.2 In situations where the height differences in [Clause 6.2.1](#) are not provided, concrete nibs are to be used to position the bottom plates of timber framed exterior walls a minimum of 150mm (or 100mm for brick veneer) above the adjacent paved ground.
- 6.2.3 It is acknowledged that due to accessibility, fire egress and the requirements of the Designing Schools in New Zealand (DSNZ) document for flexible learning spaces, threshold channels will be required at exterior doorways to achieve cladding separation from external ground (unless permeable slatted decks are used externally).

6.3 Threshold Channel Usage

- 6.3.1 With exception of exterior doorways, threshold channels must be used sparingly by the Architect / Designer as they require sumps, drainage connections and ongoing maintenance.
- 6.3.2 In order to protect interior spaces at external doorways, designers must take into account the local conditions and exposure to wind driven rain to ensure compliance with NZBC Clause E2.
- 6.3.3 Threshold channels are primarily used to achieve cladding ground separation at exterior doorway locations. Threshold channels with suitable shelter may also be continued between a set of entrance doorways that are close to each other and along the same external wall face as shown in [Figure 6-2](#) below.
- 6.3.4 Suitable shelter is defined as a covered veranda, overhanging upper storey or recessed doorway that provides a horizontal overhang width which is equal to, or greater than the vertical overhang height between exterior paving and soffit as shown in [Figures 6-1](#) and [6-2](#) below.

- 6.3.5 Threshold channels adjacent to exterior walls (in between exterior doorways) are an alternative solution to NZBC Clause E2. Building Consent Authorities are expected to require proof of compliance as part of the consenting process. This is the responsibility of the Designer.
- 6.3.6 For exposed situations where suitable shelter (as defined in 6.3.4 above) is not provided, threshold channels must be limited to use at external doorway locations only to prevent moist air being drawn up the cladding cavity – refer to Figure 6-2 below.

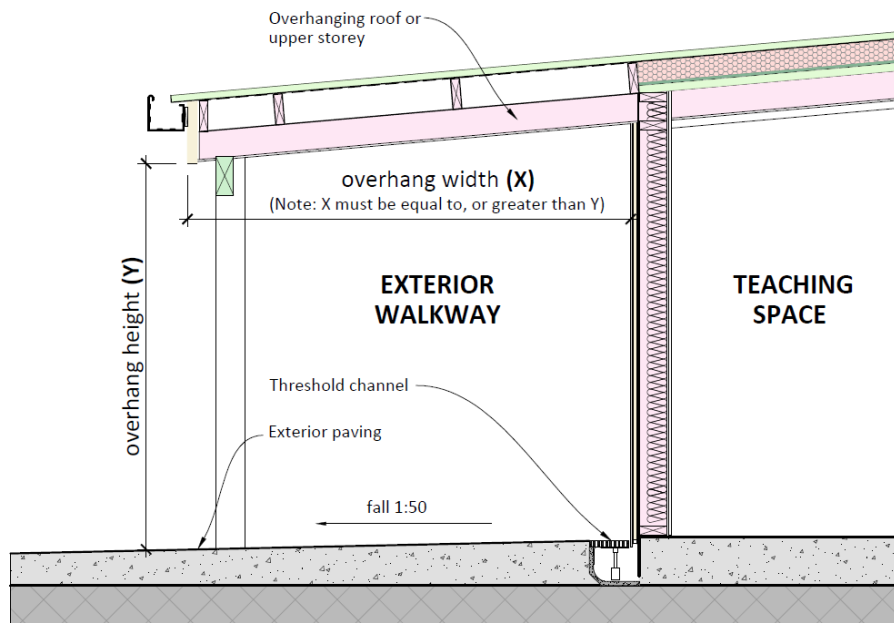

Figure 6-1 Suitable Shelter for a Threshold Channel

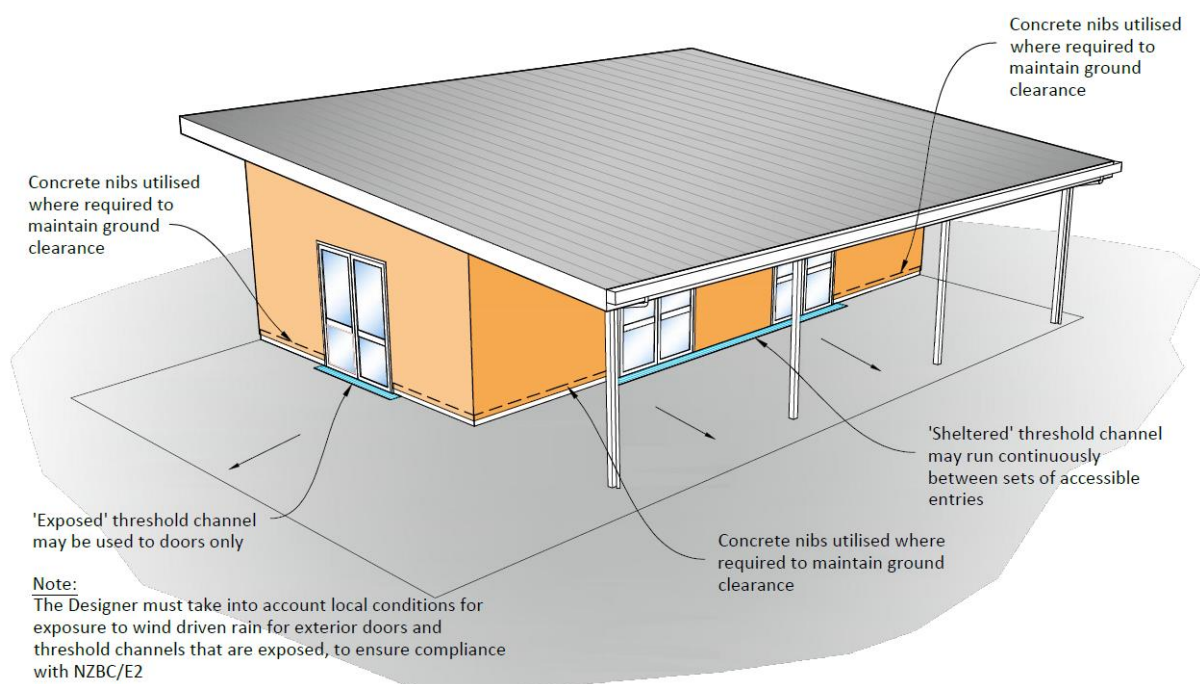

Figure 6-2 Example of Sheltered and Exposed Threshold Channels

A summary of threshold channel usage is provided in [Figure 6-3](#) below:

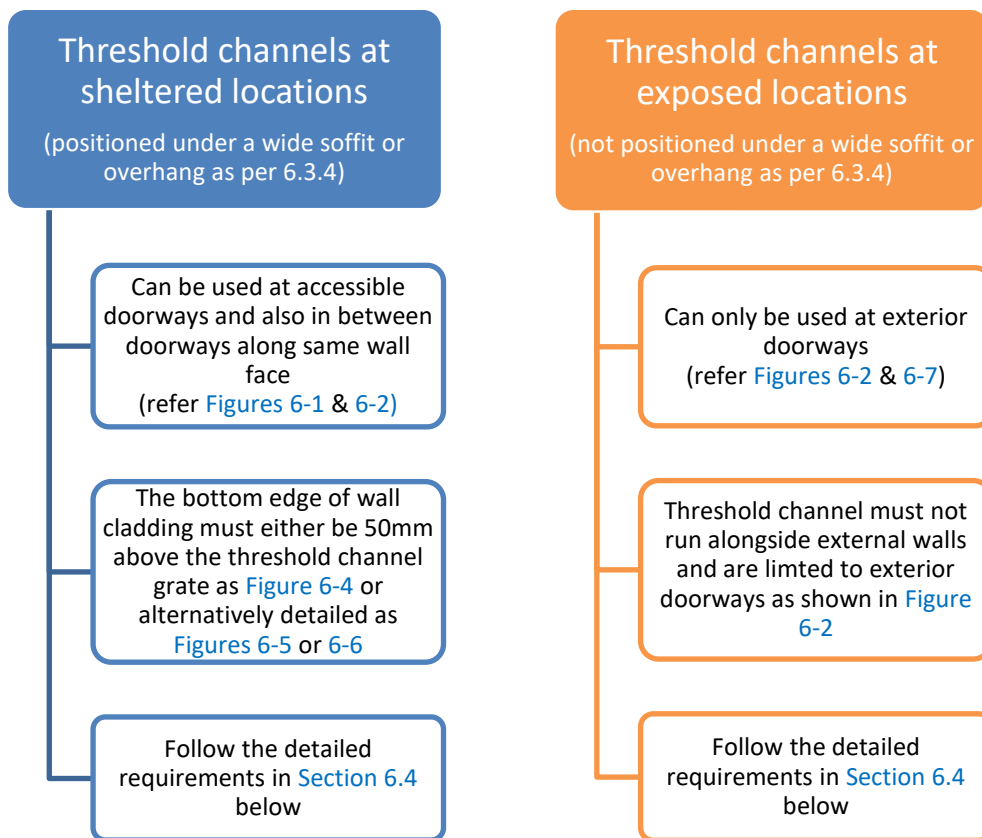

Figure 6-3 Summary Chart for Threshold Channel Usage

6.4 Threshold Channel Details

In all cases where threshold channels are used, the following requirements must be met (refer to [Figures 6-4 to 6-7](#) below):

- 6.4.1 The threshold channel must be designed as “dry in service” – i.e. the adjacent paving must flow away from the channel at a minimum slope of 1:50 and not into it, and it is designed so that no water ponds in the channel (note: 1:50 paving falls are an Alternative Solution to NZBC Clause E2).
- 6.4.2 The foundation & slab edge must be waterproofed with a liquid applied UV stable membrane.
- 6.4.3 The channel must be laid with minimum 1:200 falls to a sump connected to the stormwater system. This can include rain gardens where these are designed by a Civil Engineer.
- 6.4.4 Channel drain outlet spacing:
 - where the threshold channel is suitably sheltered as per [Clause 6.3.4](#), outlets are to be provided at maximum 7400mm centres (this aligns with BRANZ recommendations)
 - where the threshold channel is not suitably sheltered, outlets are to be provided at maximum 3700mm centres

- 6.4.5 The channel grate must be easily removable by school maintenance staff to allow regular cleaning, with consideration to preventing removal or vandalism by others if this is an anticipated issue.
- 6.4.6 The minimum clear internal width of the threshold channel is 200mm with a clear width of grating of 150mm.
- 6.4.7 Threshold channel minimum depth must be 150mm minimum at the high point of fall.
- 6.4.8 The bottom edge of cladding must be either:
- A minimum of 50mm above the threshold channel grate with use of a nib wall to achieve this (see [Figure 6-4](#)), or
 - Extended below the level of the threshold channel grate top, with the bottom edge of the cladding treated to be impervious. However, this is only for situations where the threshold channel is suitably sheltered as per [Clause 6.3.4](#) above (see [Figure 6-6](#))
- 6.4.9 The top surface of the channel grate must be set no more than 20mm below the entry threshold or internal finished floor level to meet NZBC and NZS4121 accessibility requirements (see [Figure 6-7](#)).
- 6.4.10 Three-sided pre-formed channel systems are prohibited – the required solution are systems specifically designed for level thresholds to building perimeters, of which there are a number available in the market.

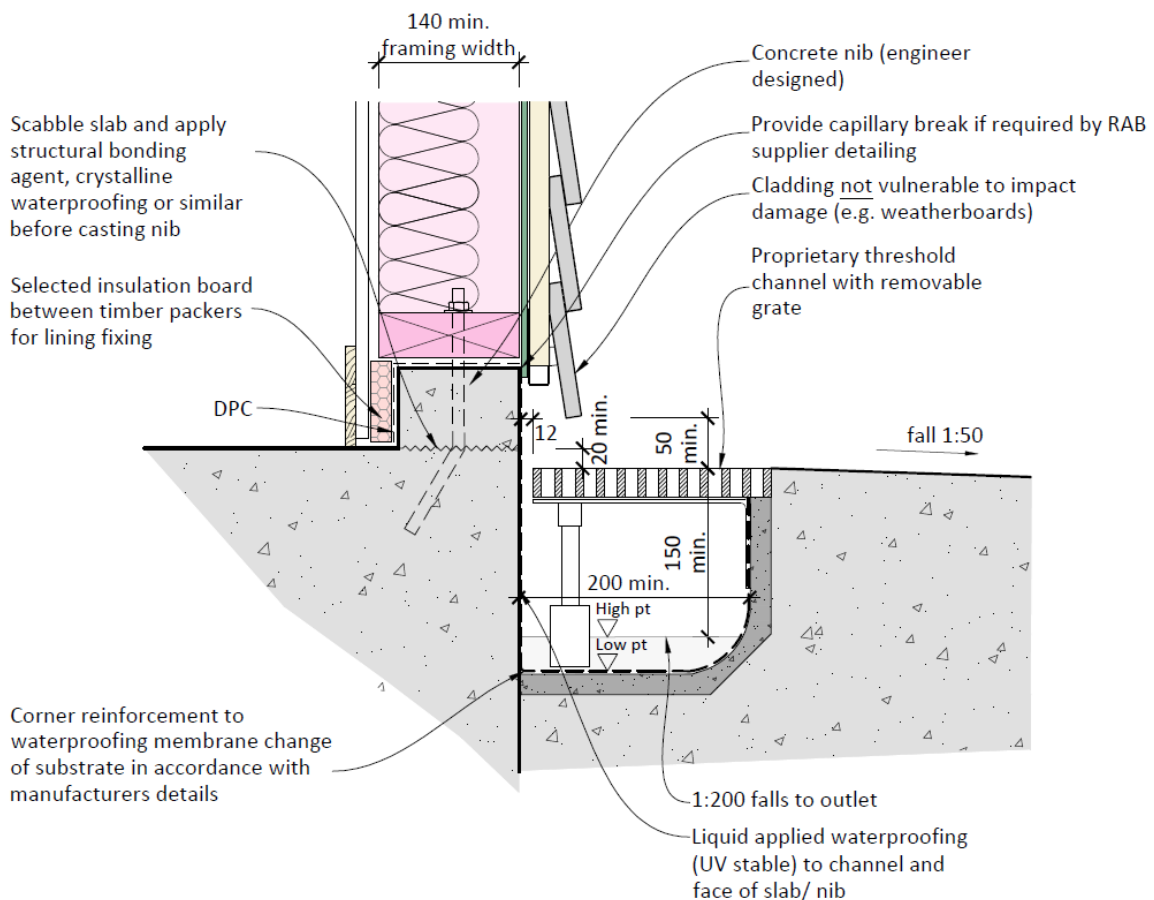

Figure 6-4 Threshold Channel to Cladding

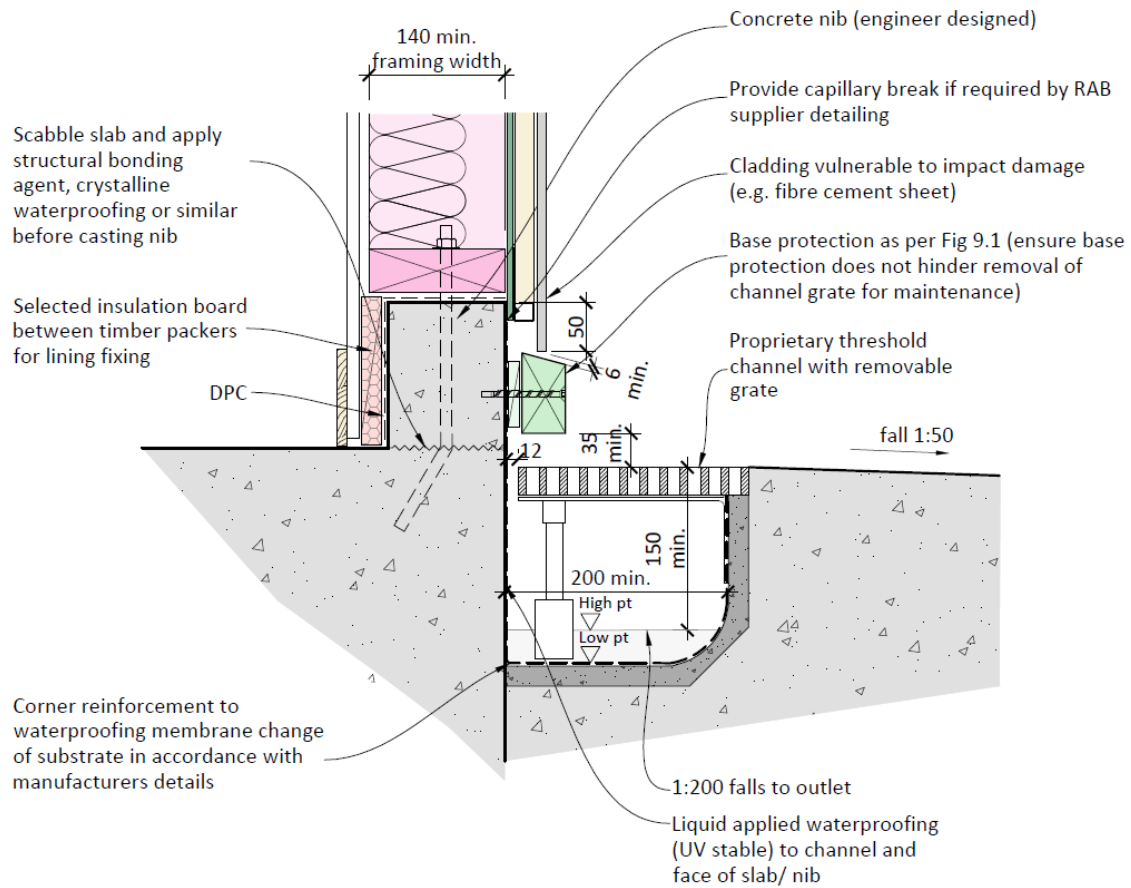

Figure 6-5 Threshold Channel to Cladding (with Cladding Base Protection)

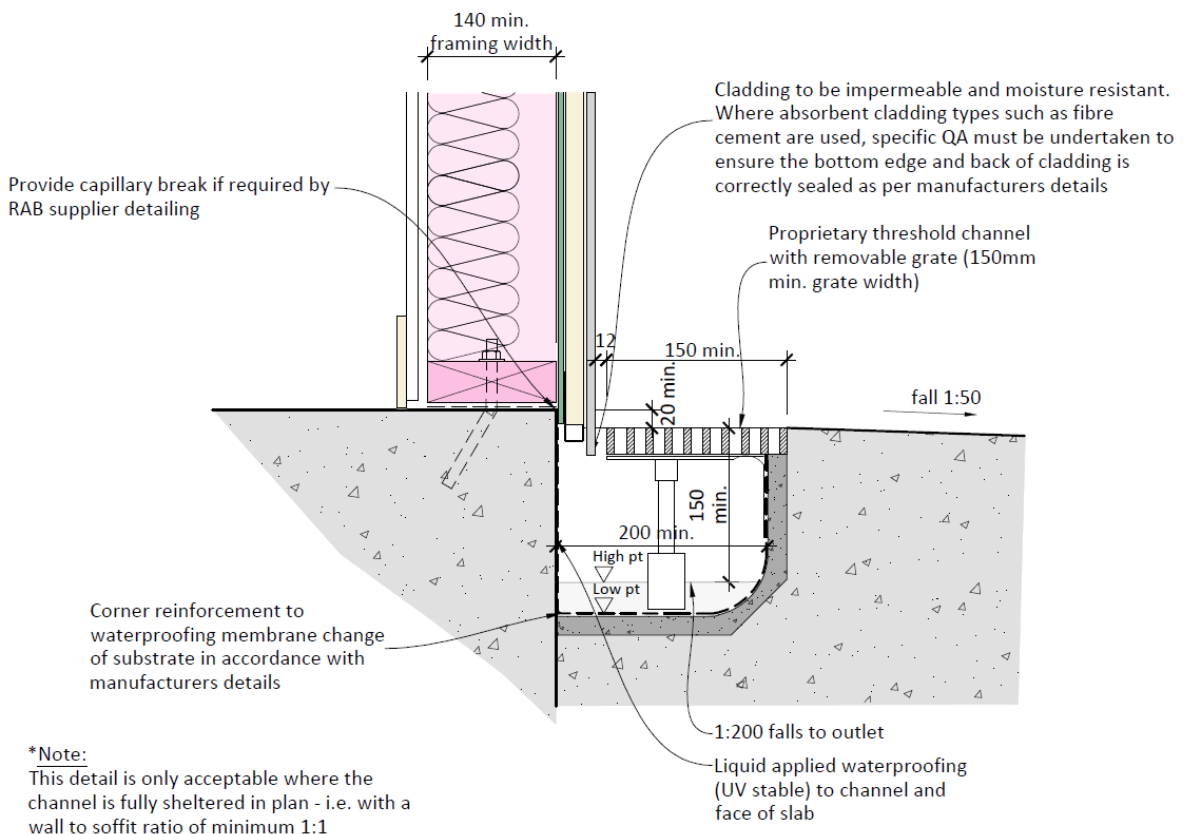

Figure 6-6 Threshold Channel to Cladding (alternative detail for sheltered locations)

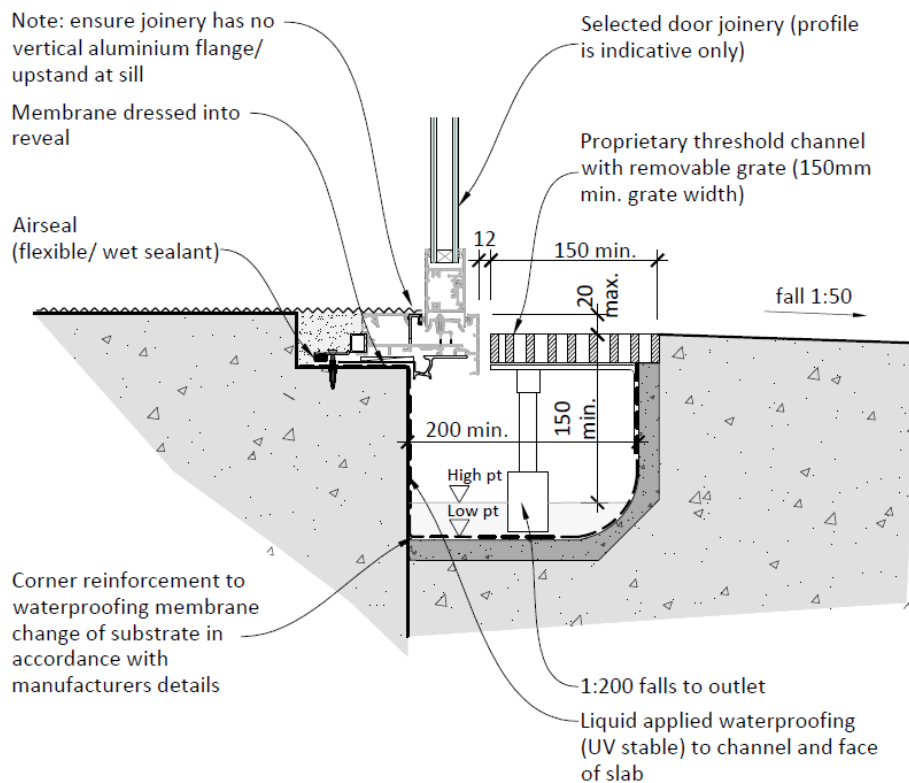

Figure 6-7 Threshold Channel to Joinery Sill

6.5 Concrete Nibs

Concrete nibs can be used to maintain cladding clearance to external ground level in limited locations where it is not practicable to apply a 150mm (or 100mm for brick veneer) step between finished floor level and adjacent outdoor paving as per [Clause 6.2.1](#) above.

Where concrete nibs are utilised, the following points must be incorporated:

- 6.5.1 They must be designed by a Structural Engineer.
- 6.5.2 They must have a minimum width of 110mm to allow for necessary construction tolerances, capillary breaks and avoidance of cold bridging to the lining. Depending on the type of rigid air barrier product used, there may be a requirement for a separation between the face of concrete and the back of the rigid air barrier (see [Figure 6-8](#) below).
- 6.5.3 Timber wall framing connected to the nib must have a minimum width of 140mm (see [Figure 6-8](#) below).
- 6.5.4 The external paving must be set to a maximum of 20mm below the internal floor level to elevate the 'cold joint' above ground level (see [Figure 6-8](#) below).
- 6.5.5 Where the nib is cast in a separate pour on top of the main floor slab, a waterstop must be provided in the form of either crystalline waterproofing, a seal that swells on contact with water or a uPVC cast-in flashing. Surface painted waterproofing membranes to the front of the nib are not effective in waterproofing the cold joint as they are prone to damage through movement, impact, or "blowing out" as construction moisture dissipates from the nib (see [Figure 6-8](#) below).

- 6.5.6 Where there are steel posts or columns in the external wall, ensure these are located so that the nib has a continuous external face for its complete length.
- 6.5.7 Where the concrete nib abuts door or full height window openings, provide details of the nib and door frame junction at low level (below cladding). One indicative solution is shown in [Figure 6-9](#) below.
- 6.5.8 In the South Island and Central Plateau (Climate Zone 3), insulation must be provided, either internally or externally, to address thermal bridging issues created by the nib and the potential for condensation (see [Figure 6-8](#) below). The Designer should also determine on a project specific basis whether this is required for projects in Climate Zones 1 and 2.
- 6.5.9 Where used, external insulation must be suitably protected from impact damage with an applied elastomeric plaster, cement render or other form of durable finish.

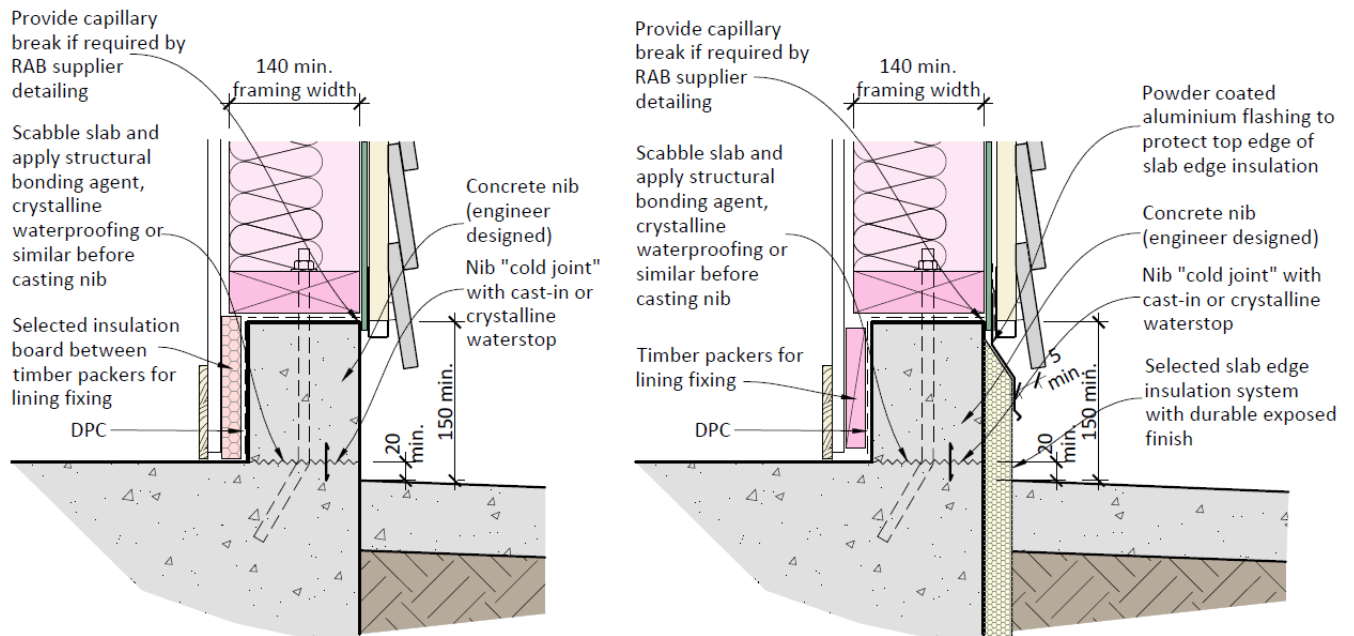

Figure 6-8 Concrete Nib Examples

Other options for concrete nibs include:

- 6.5.10 Forming the nib monolithically in the same pour as the main floor slab to eliminate the cold joint and negate the need for waterstops.
- 6.5.11 Forming the nib in the same pour as the foundation and not the floor slab. As with [6.5.10](#) above, this can negate the need for waterstops.
- 6.5.12 Considering the use of insulation to the internal face of the nib to help address potential thermal bridging issues.

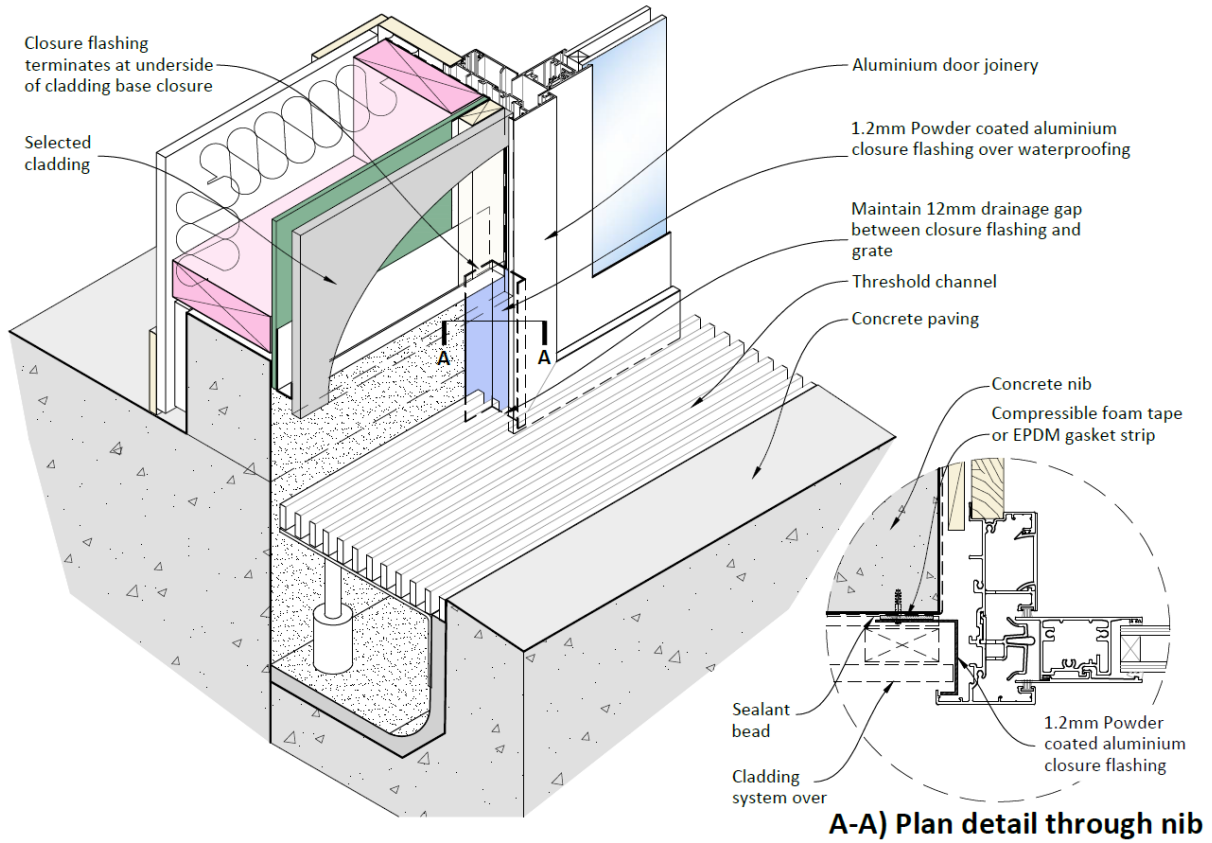

Figure 6-9 Example of Concrete Nib to Door Frame Junction

6.6 External Paving Strips

The total building perimeter including landscaped areas, must have a minimum 500mm wide strip of permanent paving set 150mm below internal finished floor level (or 100mm for brick veneer) with 30mm fall away from the building into permeable surfaces (e.g. gardens or lawn) or drainage systems as shown in Figure 6-10 below.

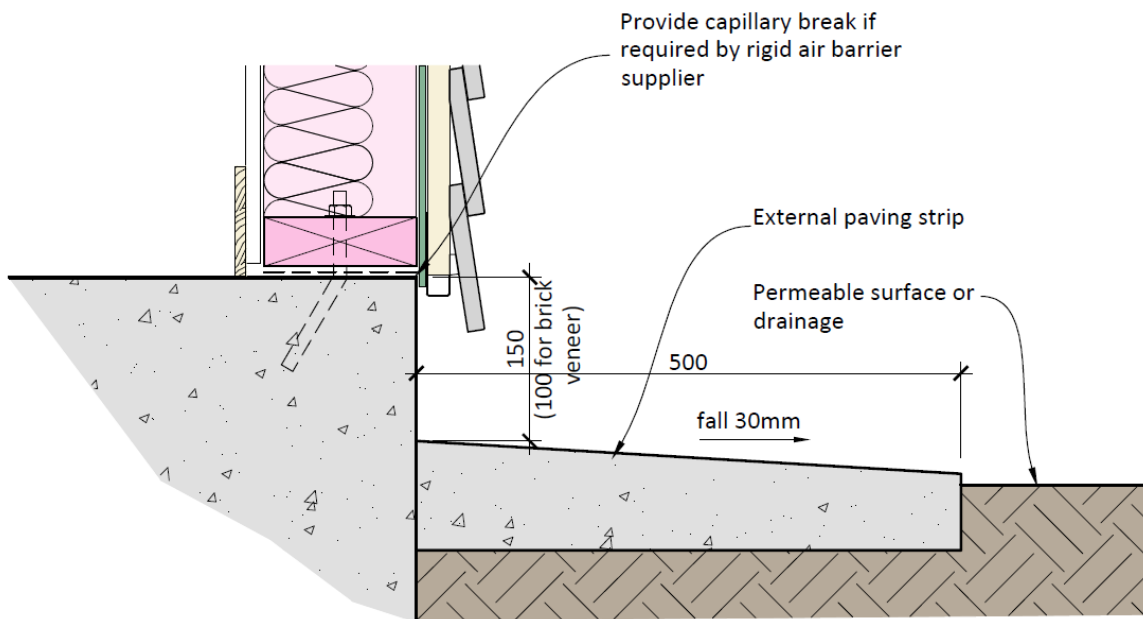

Figure 6-10 External Paving Strip

7 Suspended Timber Floors

7.1 Prohibited Items

The following materials, installations and construction systems are not to be used:

- Particleboard flooring to wet areas (e.g. toilets, bathrooms and kitchens)
- Untreated plywood to wet areas (e.g. toilets, bathrooms and kitchens)

7.2 Sub-floor Areas

Where the ground floor is supported on piles:

- 7.2.1 Sub-floor ground must be overlaid with minimum 250 micron thick polythene sheets with all joints lapped and taped.
- 7.2.2 Polythene sheets must be fitted tight around, and be taped to piles. Where perimeter walls are present, polythene sheets must also be fitted tight to, and taped to walls.
- 7.2.3 To permit visual inspection of all sub-floor areas:
 - Secure access doors or hatches are to be provided within the sub-floor external wall
 - Joists must be a minimum of 450mm above ground level
 - All piles (whether concrete or timber) must be a minimum of 300mm above ground level
- 7.2.4 Where there is a need for sub-floor ground to be excavated or set below adjacent ground levels, impervious retaining walls are to be provided. Such retaining walls are limited to no more than two sides of the building subfloor area to ensure adequate drainage and access.
- 7.2.5 Sub-floor areas must be designed to prevent any surface water flowing under the building. In all cases, sub-floor ground must be graded to prevent water ponding.
- 7.2.6 Provide subfloor ventilation in accordance with NZS3604:2011 Clause 6.14 *Prevention of Dampness*.
- 7.2.7 Vents in subfloor foundation walls must be vandal resistant and vermin-proofed with care taken to ensure that the required free-ventilation area is achieved.
- 7.2.8 Vents must be evenly distributed to all external sub-floor walls, and be provided on at least two sides of the subfloor space to ensure cross-flow ventilation.

7.3 Slatted Decks

The following requirements apply:

- 7.3.1 Where a slatted deck (i.e. rain permeable) is positioned adjacent to a suspended floor, provide a sub-floor wall to separate it from the subfloor area to prevent dampness from below the deck entering the building sub-floor area.

7.3.2 Where decks are present on more than one side of a building, uPVC pipe ducts must be provided from the building subfloor to the outer edge of the deck as shown below in Figure 7-1.

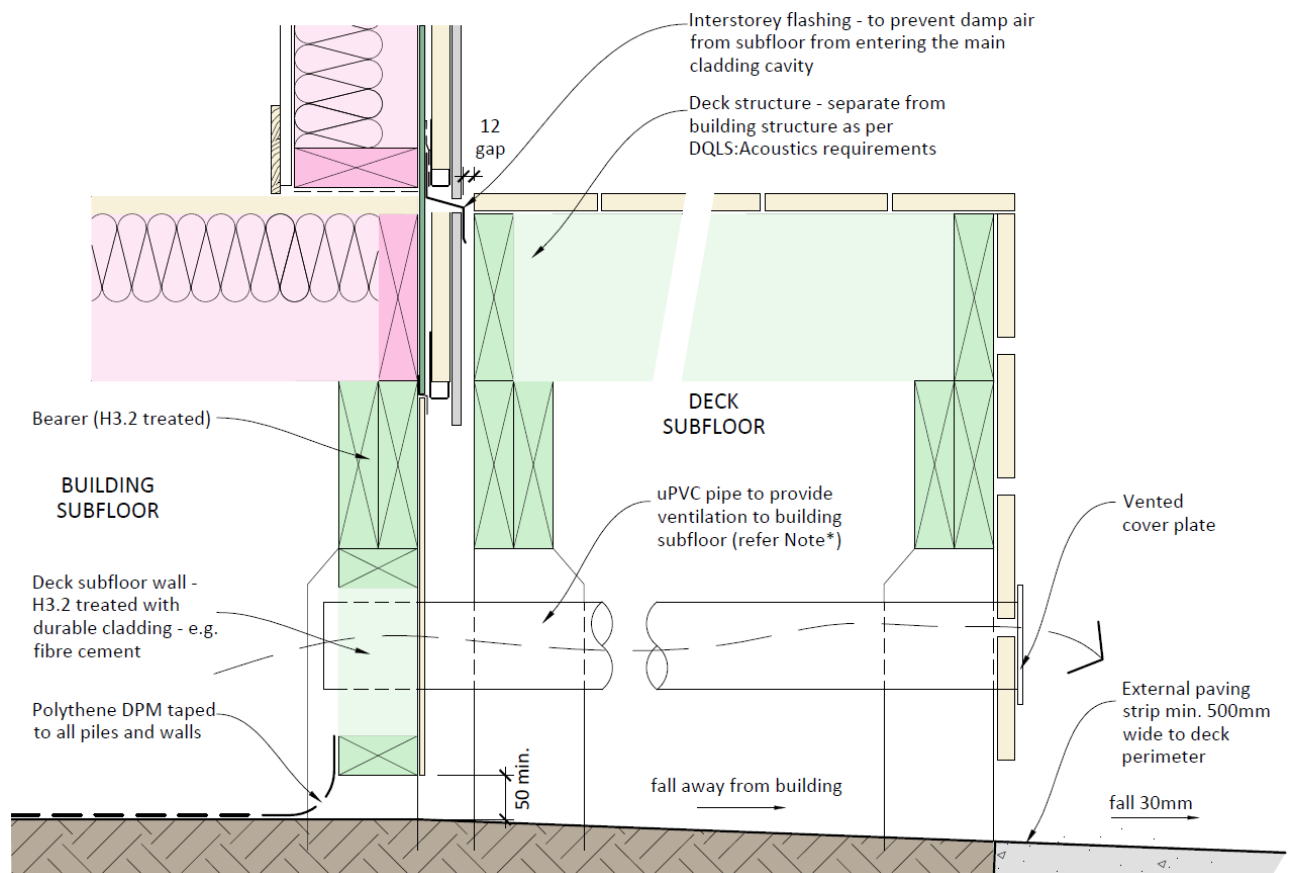

Figure 7-1 Sub-floor Wall between Deck and Building

7.4 Durability

Requirements include:

- 7.4.1 All fixings for sub-floor areas must be Type 304 stainless steel, unless there are specific site circumstances that require the use of 316 stainless steel.
- 7.4.2 All sub-floor timber framing is to comply with NZBC Acceptable Solution B2/AS1.

8 Exterior Wall Structure

8.1 Prohibited Items

The following materials, installations and construction systems are not to be used:

- Curved walls
- Walls that are not vertical
- Concrete block structural walls to habitable / occupied spaces that are not over clad
- Stack-bonded blockwork
- Honed face concrete blockwork
- Expanding foam airseals to windows
- Galvanised steel fixings (nails, bolts, plates, etc.) in contact with timber treated with copper-bearing preservatives

8.2 Timber and Steel Framed Walls

All timber and steel framed exterior walls are to be detailed to incorporate:

- 8.2.1 Exterior cladding to deflect moisture.
- 8.2.2 Drained cavity with top ventilation (refer to [Section 9.4](#) and [Figures 9-2](#) and [9-3](#)).
- 8.2.3 Rigid air barrier to the outside face of all external wall framing members (refer to [Section 9.5](#)).
- 8.2.4 Flexible (wet sealant applied) air seals over backing rod to windows.

An exemption from the requirement to provide a cavity may be given for alterations to existing buildings that have been constructed without a cavity, such as where windows are being removed and in-filled to match an adjacent surface.

8.3 Concrete Blockwork

The following requirements apply:

- 8.3.1 The base course of blockwork is to be set in a rebate at least 50mm below finished floor level.
- 8.3.2 All blockwork must be laid and solid-filled under the supervision of a Brick and Block laying Licensed Building Practitioner.
- 8.3.3 A cladding system fixed over a cavity is mandatory on the exterior face of structural blockwork walls for all habitable / occupied spaces (e.g. excluding boiler rooms).

8.4 Concrete

Walls constructed of reinforced concrete (precast or in-situ) require specific design or peer review by a suitably qualified and experienced façade engineer and the provision of an accompanying PS1 or PS2 producer statement.

The design must address the following issues:

- 8.4.1 Reliance on external waterproof coatings and sealants may not provide sufficient redundancy for maintaining weathertightness over the life of the building.
- 8.4.2 Potential issues with internal moisture control and severe thermal bridging.
- 8.4.3 Maintenance requirements over the life of the building for:
- Internal vapour control membranes, especially those with multiple services penetrations, and
 - Exterior coating systems
 - Unintended structural cracking

8.5 Timber Treatment and Fixings

The following requirements apply:

- 8.5.1 In all situations where copper-bearing preservatives are used i.e. Chromated Copper Arsenate (CCA), Copper Quat (CQ - previously Alkaline Copper Quaternary), Copper Azole (CuAz) to achieve required treatment levels (i.e. H3.2 and above), fixings are to be 304 stainless steel (nails, staples, bolts etc.) unless there are specific site circumstances that require the use of 316 stainless steel.

8.6 Junctions with Existing Buildings

The junction between the envelope of a new building and that of an existing, provides a potential source of water ingress, particularly when design requirements such as seismic junctions are involved. All such junctions are to be fully detailed in the detailed drawings.

9 Cladding Systems

9.1 Prohibited Items

The following materials, installations and construction systems are not to be used:

- Direct-fixed cladding to timber and steel framed walls
- Open jointed rain-screen cladding systems, unless a complete proprietary system is used which comprises cladding panels, mounting rails and membrane applied over the rigid air barrier
- Express jointed cladding systems which are reliant on sealant to form the cladding panel joints
- H3.1 LOSP treated plywood cladding
- H3.2 treated plywood cladding, unless primed and painted (with an oil based primer, oil based undercoat and acrylic/ water based top coat system in mid to light colour range)
- Stain or oil-finished cladding
- Monolithic cladding
- EIFS cladding
- Brick slips or adhesive fixed tiles applied to a substrate
- Honed masonry veneer
- Cladding types within 2m of finished ground levels:
 - fibre-cement cladding less than 8mm thick (depth at grooves not counted)
 - uPVC systems
- Cladding fixed over a cavity, and also used as wall bracing
- Metal cladding on walls under eaves where the cladding cannot be easily washed down through hand-held equipment from ground level
- Supporting struts under eaves and overhangs which penetrate cladding

9.2 Protection at Ground Level

Cladding within 2m of finished ground floor level is to be selected to withstand impact damage.

9.2.1 All ground floor cladding that is vulnerable to impact damage must be provided with bottom-edge protection of timber or metal as shown in [Figure 9-1](#) below. Vulnerable cladding types include:

- Fibre cement board 9mm to 15mm thickness (depth at grooves not counted)
- Profiled metal cladding

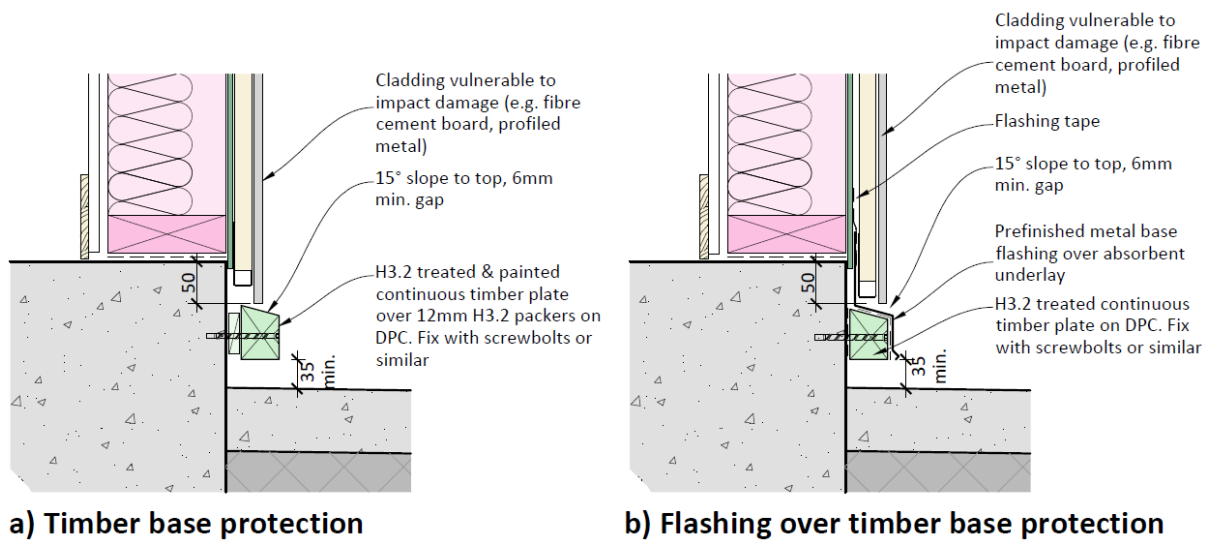

Figure 9-1 Cladding Base Protection Options

9.3 Protection at Wall Corners

Cladding systems at corner locations that are vulnerable to impact damage must have suitable exterior corner trim protection applied to withstand impact damage.

9.4 Cavity Construction - Timber and Steel Framed Walls

- 9.4.1 Cavity construction must be used for all new buildings as well as extensions and additions that create new footprint.
- 9.4.2 For existing buildings where the wall cladding has reached the end of its serviceable life, the following requirements apply:
- Where there has been satisfactory in-service performance with no weathertightness failures, and existing exterior joinery is to be retained, the cavity may be omitted if this is permitted by E2/AS1
 - Where there has been satisfactory in-service performance with no weathertightness failures, and existing exterior joinery is to be replaced, cavity construction must be used
 - Where there has been unsatisfactory in-service performance, and irrespective of whether existing exterior joinery is to be retained, cavity construction must be used
- 9.4.3 Cavities may be continuous for a maximum of two storeys in height (subject to cladding supplier and E2/AS1 limitations).
- 9.4.4 For buildings with multiple fire compartmentation cells, a check must be made to determine whether the cavity needs to be fire-stopped between floor levels or separating walls. Such fire stopping details must be designed in such a way that they do not inhibit cavity drainage.
- 9.4.5 For cavity systems to fire rated walls, a check must be made to determine whether non-combustible cavity battens are required.

9.4.6 Cavities are to be:

- Compartmentalised at external and internal corners to provide separation from cavities on adjoining wall faces to avoid undue wind pressure differentials and to allow pressure equalisation / moderation to occur – refer to [Figure 9-2](#)
- Separated from roof and subfloor areas to allow pressure equalisation / moderation to occur and to avoid transfer of moisture from the ground - refer to [Figures 7-1 and 9-3](#)
- Drained to allow any moisture that penetrates the cladding to escape
- Top vented on buildings up to two storeys in height to assist drying by allowing air movement to aid evaporation - refer to [Figure 9-3](#) (the Ministry has obtained Determination 2013/046 to allow top-venting)
- Provided with a method of draining at each floor level where a building exceeds two storeys in height unless otherwise recommended by the cladding manufacturer's requirements
- Vermin-proofed by cavity closers with holes or slots to maintain drying and venting to protect all framing voids and cavities

9.4.7 Cavity battens providing support for cladding fixed horizontally (e.g. bevel-back or rusticated weatherboard), are to be:

- H3.1 timber and fixed vertically
- Installed to maintain the openness of the wall cavity (for drainage and ventilation) and positioned to support the cladding at the centres required by the manufacturer

9.4.8 Where claddings such as profiled metal sheet, vertical weatherboards etc. are fixed vertically and horizontal battens are required, the battens must allow free drainage and ventilation. Only proprietary products such as extruded proprietary polypropylene battens or treated proprietary dual castellation battens (where they form part of a tested cladding system) may be used.

9.4.9 Cavity spacers providing intermittent support for fixings or wall penetrations are to be short lengths, and set to a slight fall (5° minimum from horizontal) to allow drainage of any moisture from the top.

9.4.10 Rain-screen cladding systems utilising galvanised steel or aluminium rails or top hats to form a cavity system may be used provided they are supported with proof of NZBC compliance such as a BRANZ Appraisal or NZS4284 testing.

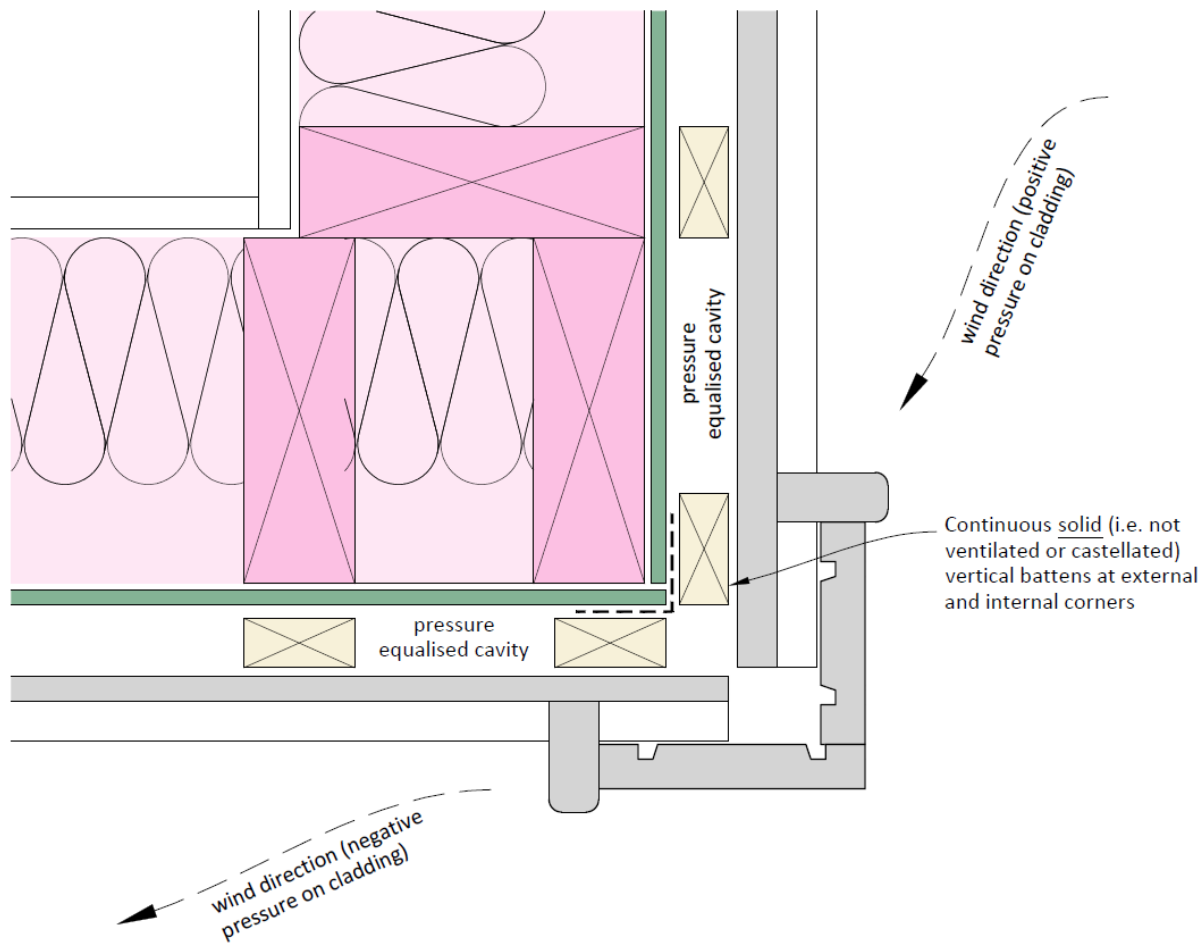
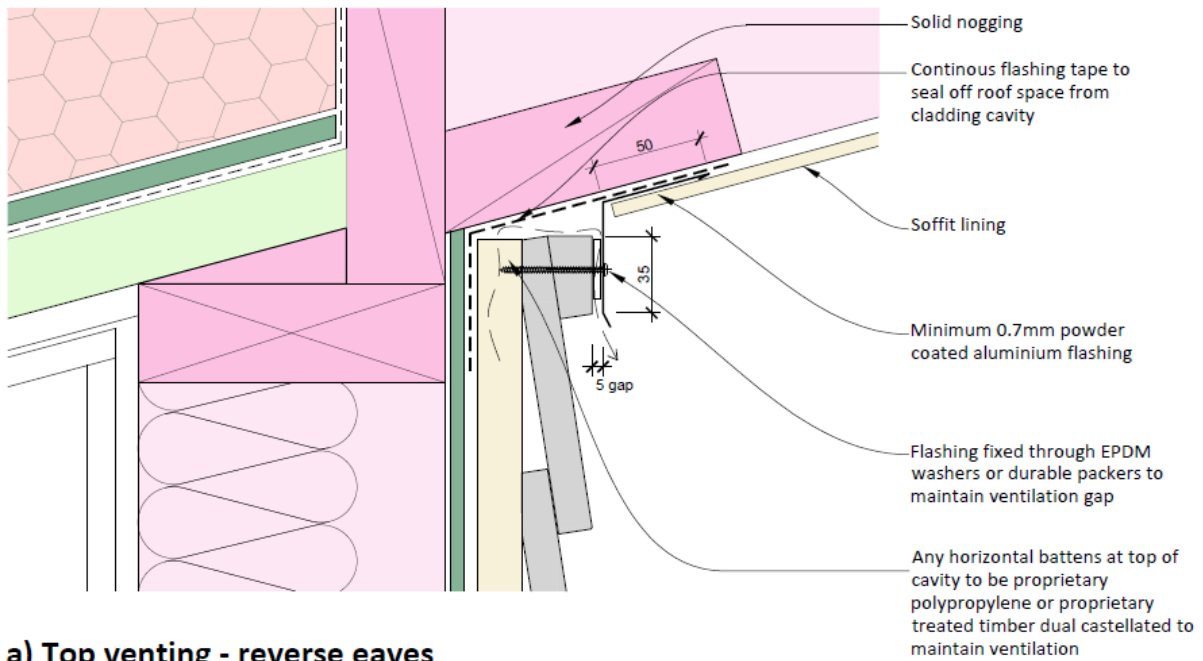
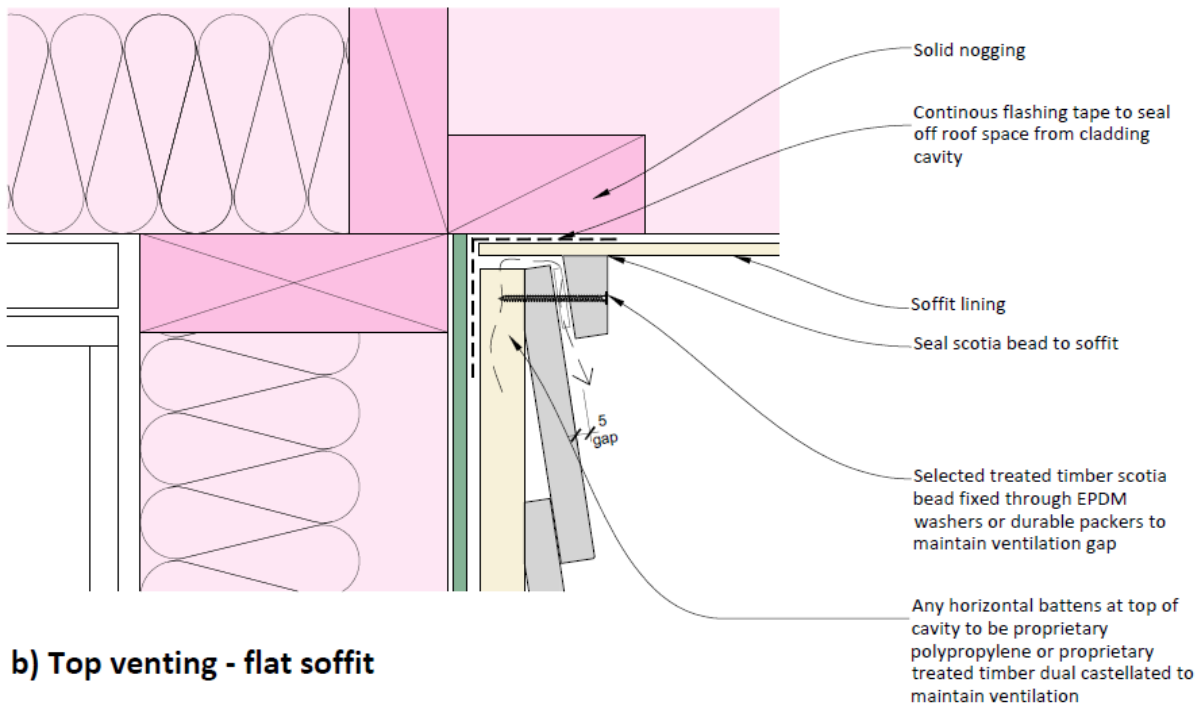

Figure 9-2 Cavity Compartmentalisation at Corner



a) Top venting - reverse eaves



b) Top venting - flat soffit

Figure 9-3 Top Venting

9.5 Rigid Air Barriers - Timber and Steel Framed Walls

9.5.1 Rigid air barriers are to be used for all buildings.

9.5.2 Rigid air barriers are to be tested and BRANZ appraised proprietary fully taped systems based on materials or products such as:

- Fibre cement (minimum 6mm thick)
- H3.2 treated plywood (minimum 7mm thick) with stainless steel fixings

- Water resistant fibreglass reinforced gypsum
- Oriented Strandboard (OSB) with laminated wall underlay
- Cross Laminated Timber (CLT) (when used as a structural wall system) with BRANZ Appraised self-adhesive underlay

9.5.3 In areas of high seismicity (as defined by the Building Act 2004), fibre cement rigid air barrier must be overlaid with a flexible building-wrap or BRANZ appraised self-adhesive layer to ensure the weathertightness integrity is maintained if the rigid air barrier is damaged as a result of a seismic event (where the rigid air barrier cannot be readily inspected for damage).

9.5.4 Where the rigid air barrier is overlaid with a wall underlay it is the responsibility of the Designer to confirm compatibility, fixing and warranty requirements with both the rigid air barrier and underlay suppliers.

9.6 Metal Wall Cladding

Profiled metal cladding is a commonly used and affordable cladding system that is widely used for school buildings. The cladding is appropriate for simple walls with few penetrations or openings, but inexperienced applicators can struggle with complex junctions, especially when internal and external corners coincide with window openings.

The following requirements apply:

9.6.1 Except where more stringent requirements are given in this document, metal wall cladding must be detailed and installed to comply with the NZ Metal Roof and Wall Cladding Code of Practice Version 3, or with the manufacturer's installation specification and details where proprietary tested systems are used.

9.6.2 Consideration should be given to avoiding the use of profiled metal cladding for complex wall elevations with multiple junctions, openings and penetrations where complex flashings are required.

9.6.3 Ensure all surfaces of profiled metal cladding systems are exposed for natural washing by rainwater, or can be easily washed down through hand-held equipment from ground level.

9.6.4 Provide bottom edge protection where required by [Section 9.2](#).

9.7 Masonry Veneer Cladding

Reference should be made to the Ministry's Structural and Geotechnical Requirements (SGR) for guidance and limitations on usage.

When concrete masonry is used as a veneer, control joints are to be detailed and control joint locations shown on the elevations.

9.8 Exposed Structural Elements

In general, structural elements may only penetrate cladding where there is no other feasible option. Projecting structural beams, outrigger elements and cantilevered joists for decks should be avoided as these are all potential sources of water ingress.

Other key points include:

- 9.8.1 External elements such as escape stairs and steel decks are best kept as free-standing structures to avoid penetrations.
- 9.8.2 Sun-shade structures should keep cladding penetrations to a minimum and use regular shaped profiles that keep flashing details simple. Circular hollow section (CHS), rectangular hollow section (RHS) or steel fin profiles are easier to flash against in comparison to universal beam (UB) or Parallel Flange Channel (PFC) sections.
- 9.8.3 Structural beams or outriggers should be enclosed in the soffit or otherwise suitably enclosed so that cladding penetrations are not necessary.
- 9.8.4 Full 3D detailing must be provided for all penetration situations through the external envelope.

10 Roof

10.1 Prohibited Items

The following materials, installations and construction systems are not to be used:

- Low pitched roofs (see [Clauses 10.2.4](#) and [10.8.7](#) below)
- Curved metal roofs
- Parapets (including solid framed deck balustrades)
- Liquid applied membranes to roofs
- Butyl Rubber and EPDM Membranes
- Reflective paint systems over torch-on roofing membranes
- Pressed metal tiles
- Reliance on sealant at joints / junctions for weathertightness
- Internal gutters and scuppers
- PVC spouting systems (unless matching the existing for an extension or addition)
- Leaf gutter mesh
- Overhangs where the underside of metal roofing is exposed
- Oiled or stain finished treatments for plywood or timber soffits
- Services plant, such as heat pump outdoor units (with exception of solar panels and/or fan cowls for extraction and supply air), are not to be located on roofs

10.2 Metal Roofing - General

Climate change has resulted in more intensive rainfall and as a consequence, a conservative approach to roof design and rainwater collection systems is required. Other considerations include the use of warm roofs as the Ministry's preferred roof type for new school buildings as covered in [Section 10.16](#) below.

The following requirements apply:

- 10.2.1 With reference to E1/AS1 and the NZ Metal Roof and Wall Cladding Code of Practice Version 3.0, use a minimum rainfall intensity of 100mm/hr for the design of collection and disposal systems for roof areas.
- 10.2.2 Metal-clad roofs are to be detailed and installed to comply with NZ Metal Roof and Wall Cladding Code of Practice Version 3.0 except where more stringent requirements are given in this document.
- 10.2.3 The minimum Base Metal Thickness (BMT) for all steel roofs must be 0.55 mm.
- 10.2.4 The minimum roof pitch for new buildings must be:
- Trough and trapezoidal section profile metal roofing - 5 degrees
 - Corrugated profile metal roofing - 12 degrees
- 10.2.5 For existing buildings where the roof cladding system has reached the end of its serviceable life, the following requirements apply:
- Where there has been satisfactory in-service performance with no weathertightness failures, there is no requirement to re-pitch the roof providing it can be

demonstrated that the new roof cladding will continue to be code compliant for the remaining life of the building

- Where there has been unsatisfactory in-service performance, the minimum roof pitches identified in E2/ AS1 or the NZ Metal Roof and Wall Cladding Code of Practice Version 3.0 must be achieved

10.2.6 The preferred maximum roof pitch is 25 degrees for safer maintenance access. However, a steeper pitch may be required to match existing adjacent buildings (e.g. heritage considerations) or when replacing existing roofs.

10.3 Metal Roofing - Underlay

Roof underlay must:

- 10.3.1 Have a current BRANZ Appraisal.
- 10.3.2 Be fully supported (mesh must comply with Safety Mesh Standard AS/NZS 4389:1996). Where underlay is stated by the manufacturer to be 'self-supporting', mesh must still be provided regardless of purlin spacing.
- 10.3.3 Be separated from insulation by a 20mm air gap (except where proprietary warm roof systems with moisture resistant board insulation are used).
- 10.3.4 Be water resistant, absorptive (hydrophobic), permeable synthetic non-woven (polymeric) type complying with Table 23 E2/AS1.
- 10.3.5 Have side and end laps of 150mm (or as per the manufacturer's requirements, whichever is greater).
- 10.3.6 Be laid horizontally (except on roofs > 8 degrees where it may be laid vertically).
- 10.3.7 Have all penetrations, junctions, and laps (where laid vertically as per [Clause 10.3.6](#)) sealed with a compatible designer / manufacturer approved window sealing tape.

10.4 Metal Roofing - Penetrations

The following requirements apply:

- 10.4.1 Penetrations are to be kept to a minimum (leaks are often associated with roof penetrations). Roof mounted plant (e.g. air conditioning units) are not permitted – these should be ground mounted.
- 10.4.2 The top face of large roof penetrations (e.g. skylights, vent cowls) are to be located within 2.5m of the ridgeline to minimise the length of back flashing needed from the penetration to the ridge above it. Refer also to the Roofing Code of Practice which limits watershed flashings to a maximum width of 1200mm.
- 10.4.3 Square or box form penetrations must be detailed with a welded 'cricket' diverter flashing formed from 1.6mm minimum thickness welded aluminium and over-flashed to the ridge. Alternatively, the penetration can be turned in plan through 45 degrees.
- 10.4.4 Small penetrations (e.g. pipes) are to be directed within the roof structure to emerge at sensible locations (e.g. well clear of other flashings or roof junctions to avoid clashes). Penetrations greater than 300 x 300mm must be fully supported all round.

10.4.5 All roof penetrations and roof mounted fixings (e.g. sky aerials, fall arrest system hooks etc.) must be detailed in the drawing set. Fall arrest systems must be designed by a suitably qualified person.

Refer to [Figures 10-1](#) and [10-2](#) below for a typical skylight flashing and vent-pipe detail.

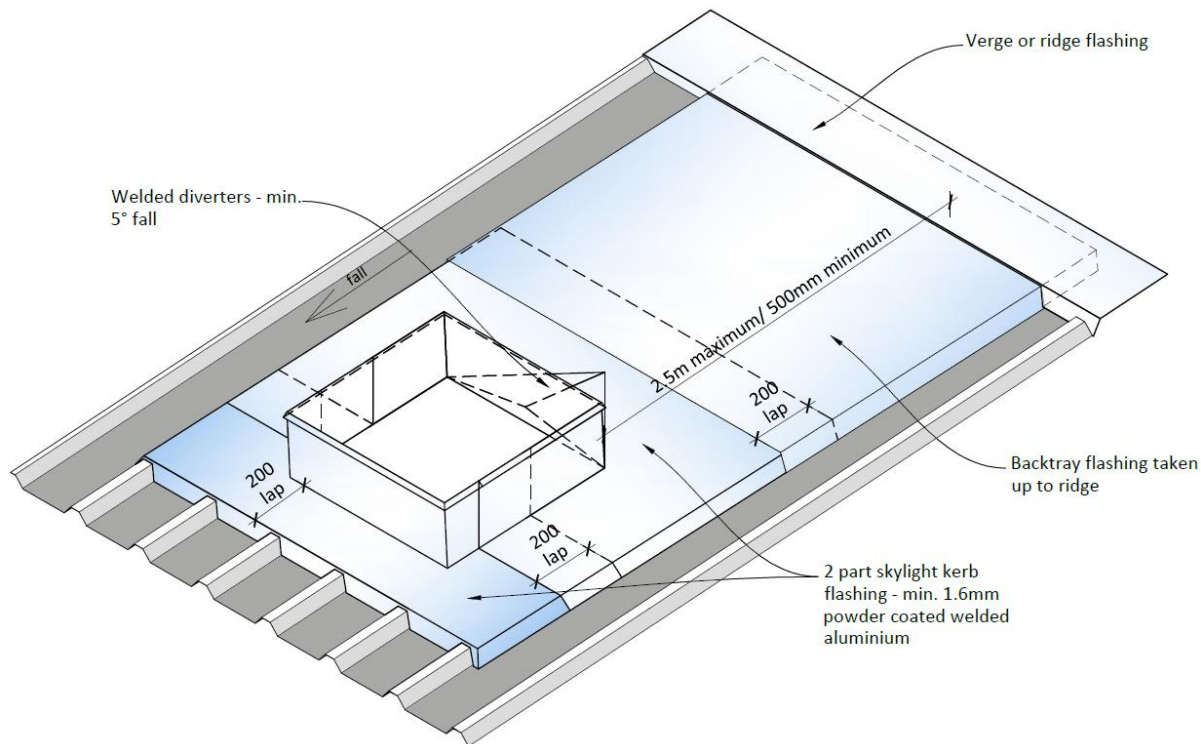

Figure 10-1 Typical Skylight Flashing

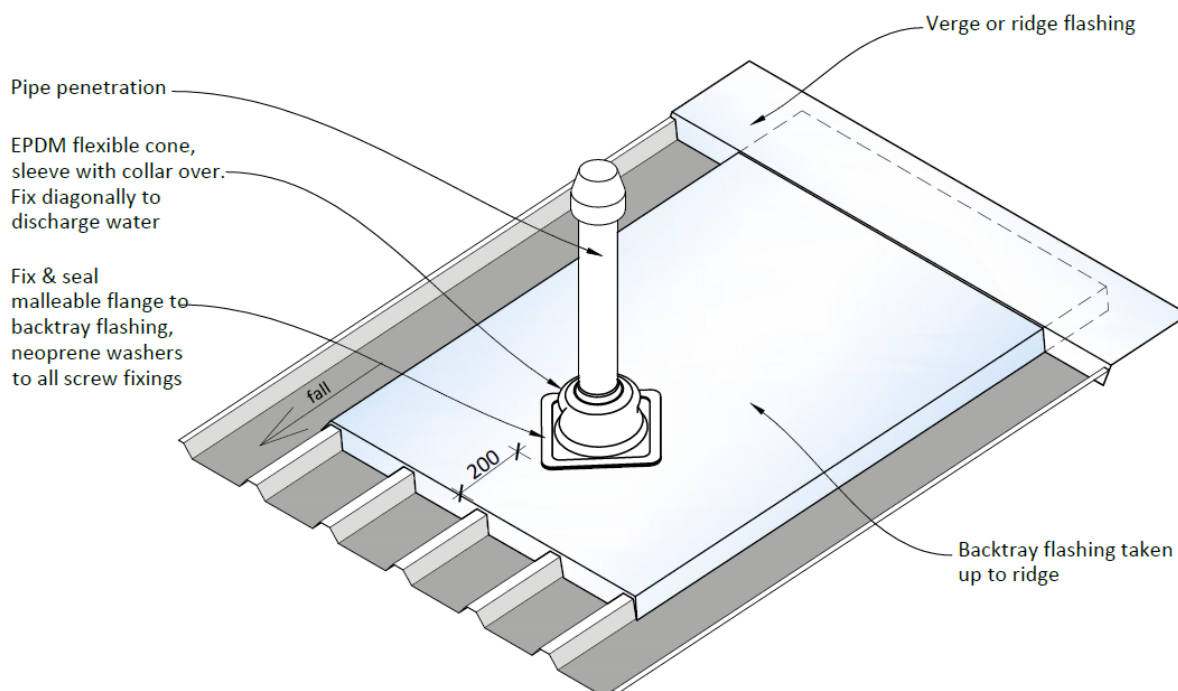

Figure 10-2 Typical Roof Pipe Penetration

10.5 Metal Roofing - Flashings

10.5.1 Flashing materials are to be generally as per the [Table 1](#) below. A typical two part apron flashing is also shown in [Figure 10-3](#) below.

Flashing type	Example	Material
Standard roof flashings which are rain washed and can be easily replaced when the roof is replaced	Ridge, barge, verge, eaves	Same material as the roof (e.g. 0.55mm pre-painted steel)
Roof flashings which cannot be replaced without removing adjacent cladding, or are in sheltered locations	Apron, parallel gutter	0.9mm powder coated aluminium, or use two part flashing as per Figure 10-3
Complex roof junctions	Compound flashing (the assembly involves more than two planes), such as: <ul style="list-style-type: none"> • Intersection of two opposing barges • Skylight cricket/ diverter flashing 	1.6mm or 2mm powder coated fully welded aluminium
Cladding flashings for pre-painted steel cladding	Corner flashings, window flashings	Same material as the cladding (e.g. 0.55mm pre-painted steel)
Cladding flashings for other cladding types (weatherboard, fibre cement etc.)	Corner flashings, window flashings, soffit flashings	Minimum 0.7mm powder coated aluminium, or uPVC, or as per suppliers proprietary tested system details

Table 1 Flashing Materials and Thicknesses

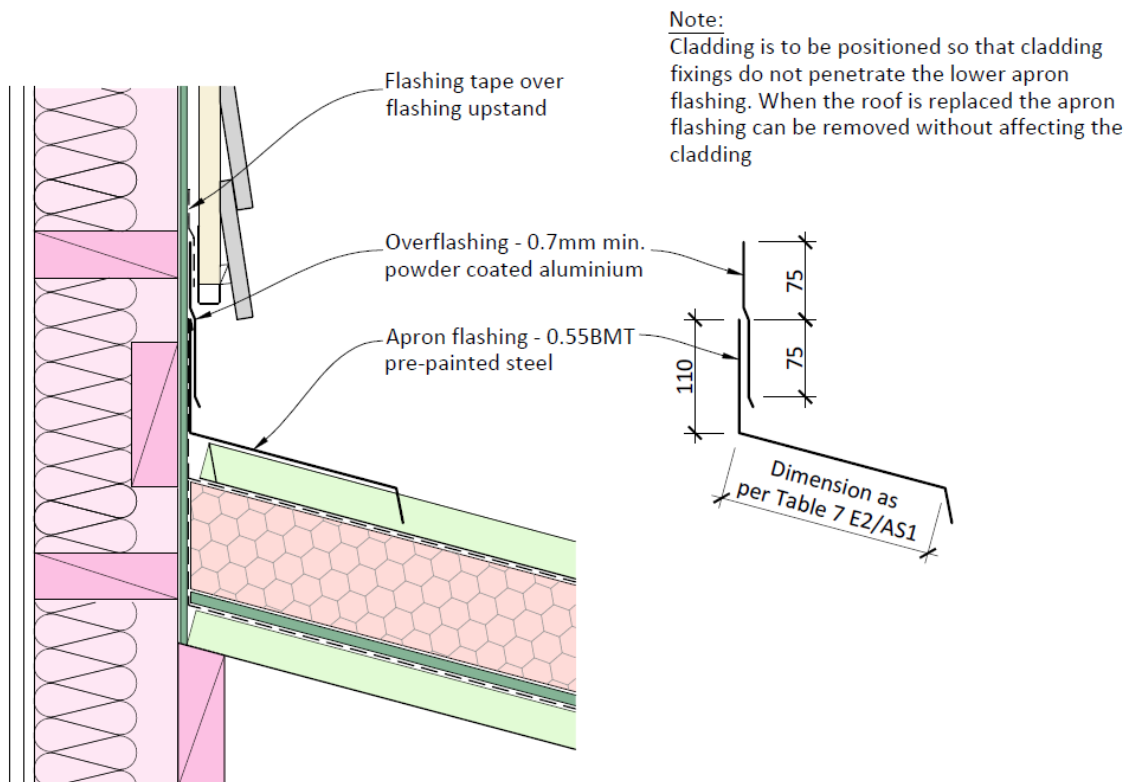

Figure 10-3 Typical Two Part Apron Flashing

10.5.2 Complex junctions are defined when the flashing assembly involves three planes (e.g. vertical, horizontal and sloping) that are joined together to form a continuous watertight barrier.

10.5.3 Flashings to complex junctions must be formed of powder coated aluminium with all joints fully welded (refer also to [Table 1](#) above for thickness).

10.5.4 All complex roof junctions are to be fully detailed in three dimensions. Refer to [Figures 10-4, 10-6 and 10-7](#) below. These are examples only; bespoke details are required to suit the specific requirements of each individual project.

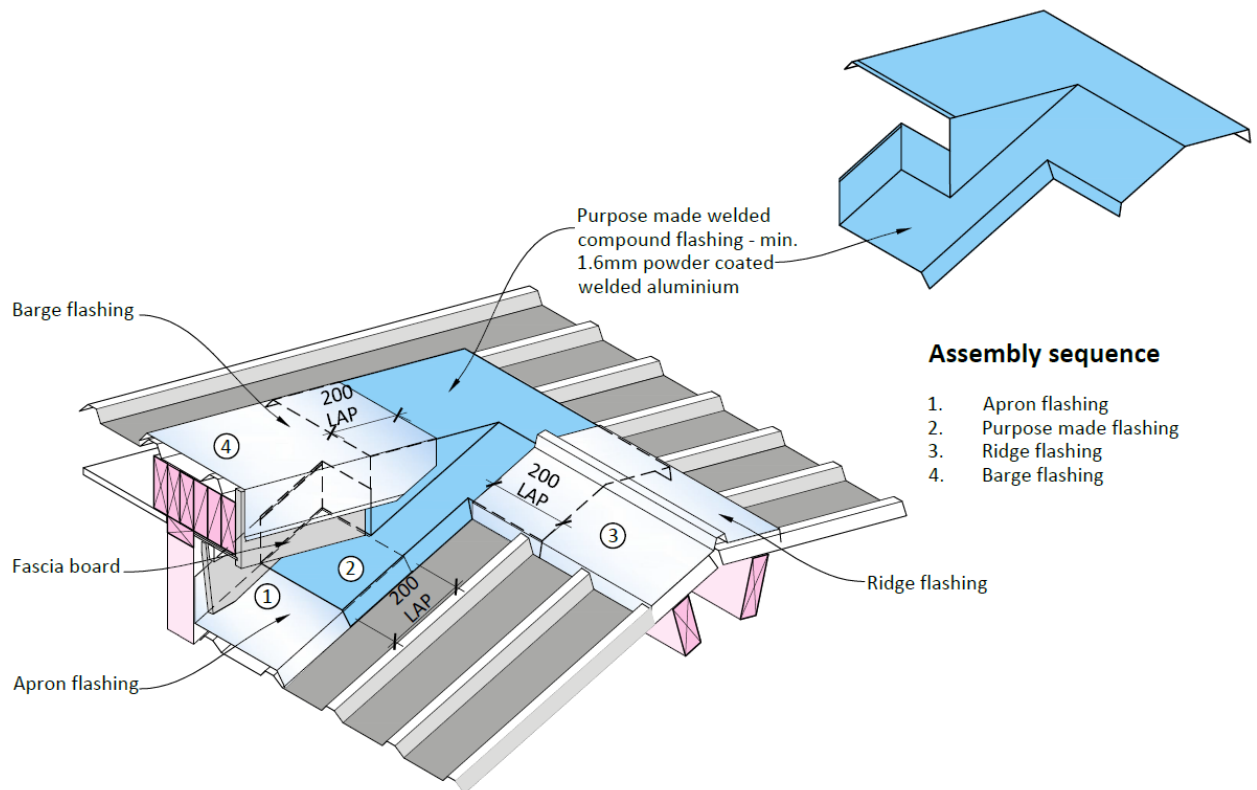

Figure 10-4 Example of 3D junction - Roof to Barge

10.5.5 Where a barge flashing is terminated partway up a roof, the barge flashing termination is required to be over flashed with a back tray flashing up to the ridge, verge or apron as shown below in [Figure 10-5](#).

10.5.6 A barge flashing at wall and corner wall situations are shown in [Figures 10-6 and 10-7](#) below.

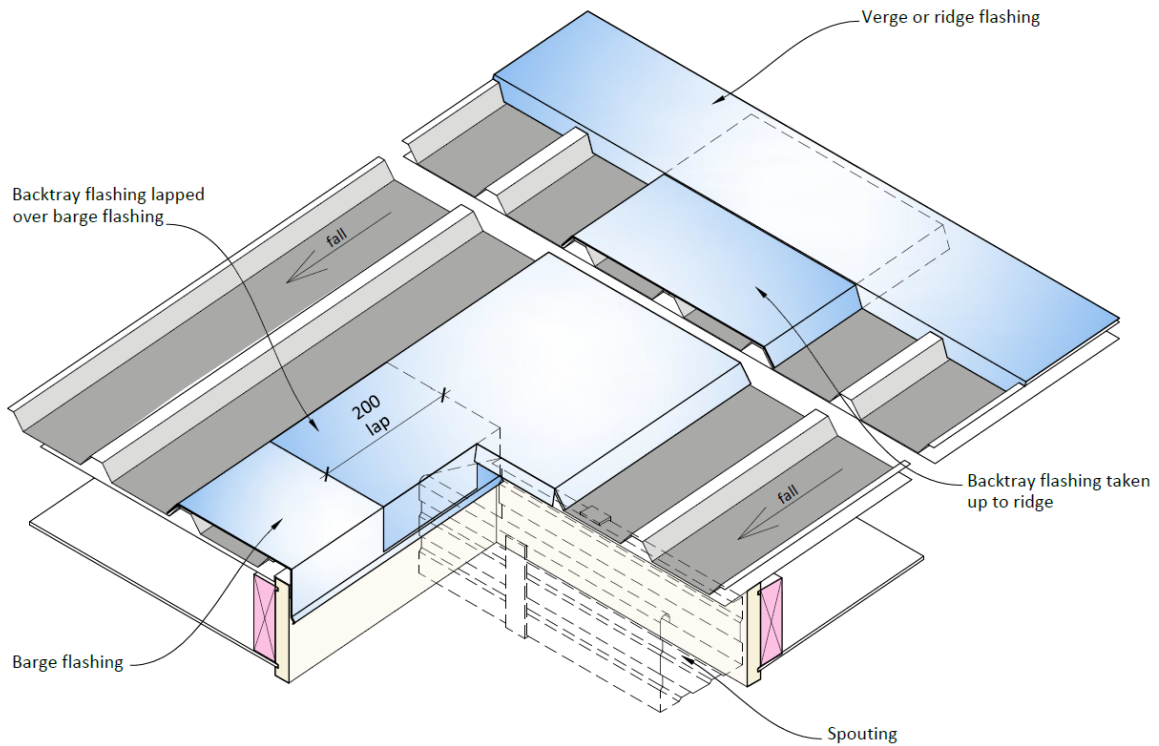

Figure 10-5 Barge Termination Partway up a Roof

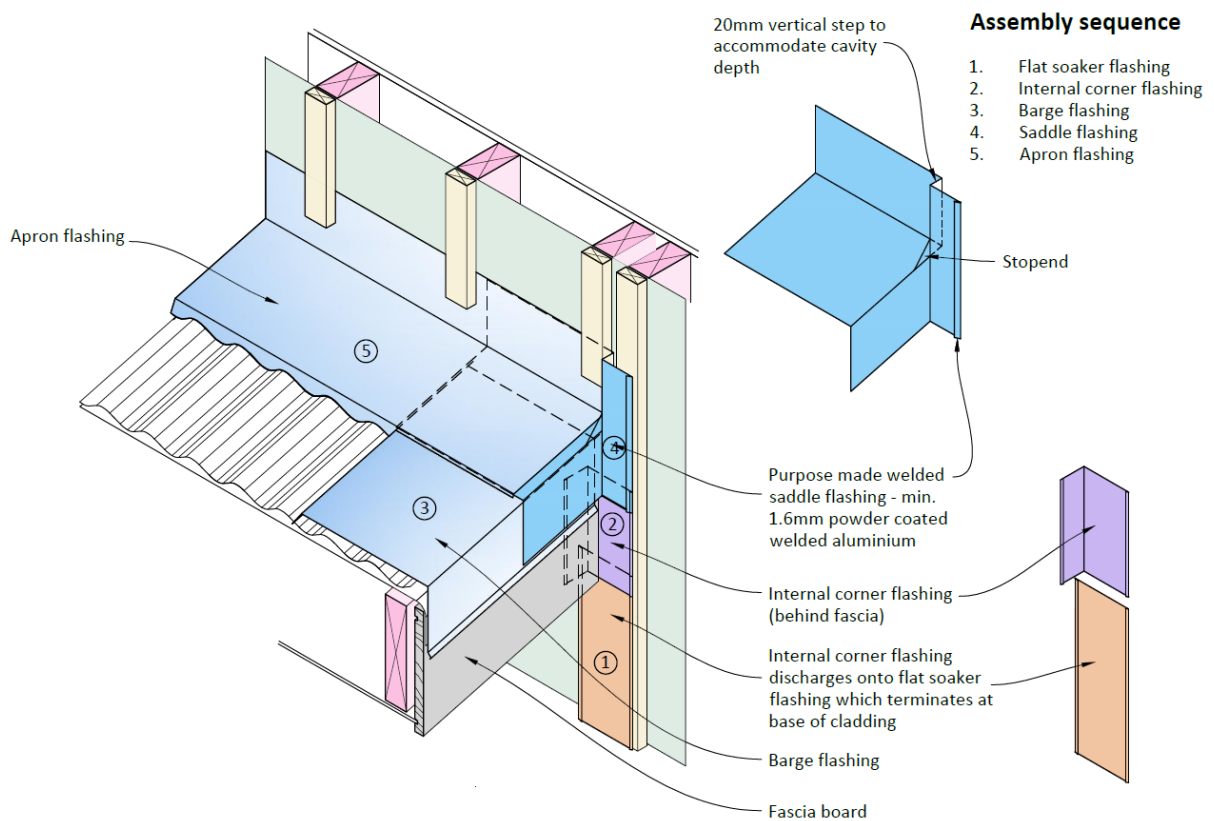

Figure 10-6 Example of 3D Junction - Barge Flashing to Wall

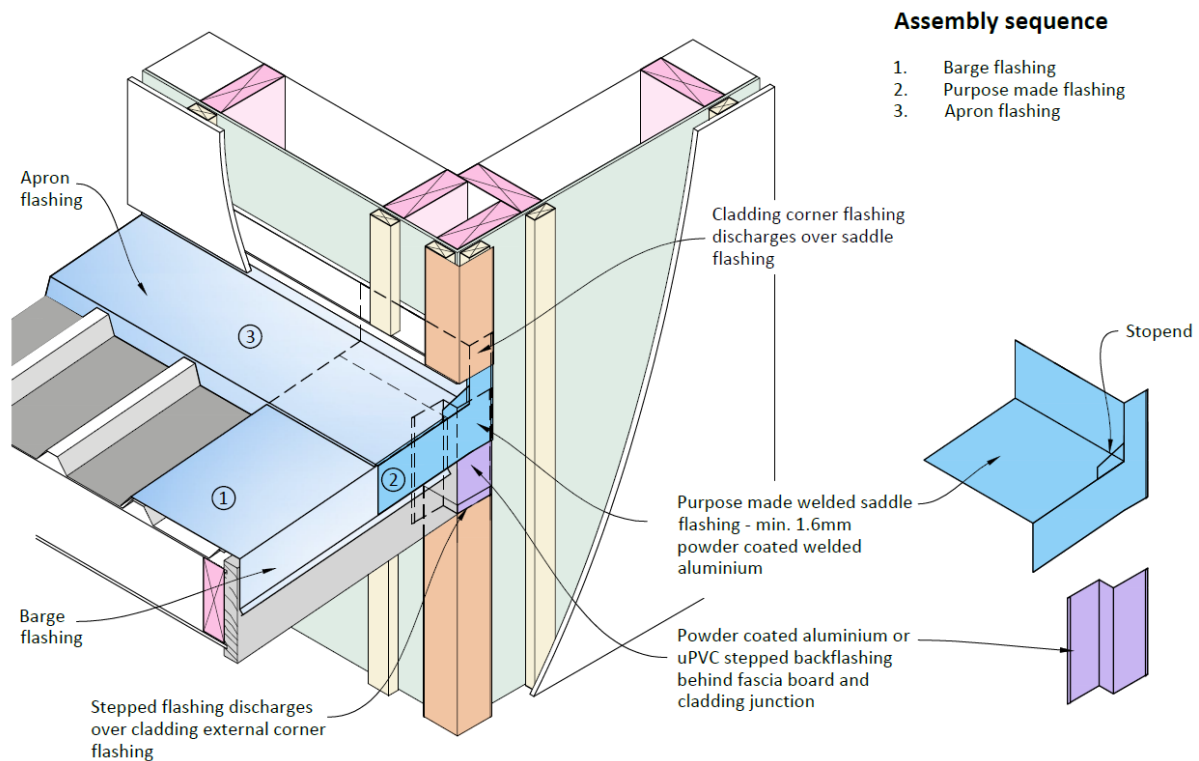

Figure 10-7 Example of 3D Junction - Barge Flashing at a Corner Wall

10.6 Metal Roofing - Valley Gutters

10.6.1 Valley gutters must be designed in accordance with section 5-2-4 of NZ Metal Roof and Wall Cladding Code of Practice Version 3.0.

10.7 Metal Roofing – Ventilation

Careful consideration must be given by the Designer to roof space ventilation and prevention of internal moisture issues in the roof space. In this regard, warm roofs are the Ministry's preferred roof type for new school buildings as covered in Section 10.16 below.

The following requirements apply for 'cold-roof' situations:

- 10.7.1 Provide cross ventilation between the roof-space voids below the roofing substrate.
- 10.7.2 Roof space ventilation must be provided to disperse internal moisture and prevent condensation within the roof space. Ventilation options include proprietary ventilation batten systems (with vents at the eaves and ridge) or soffit vents.
- 10.7.3 Vents must be designed to ensure the roof remains water-tight.

10.8 Membrane Roofing - General

Projects which incorporate membrane roofing require precise detailing and an increased level of attendance and observation by the Designer at the time the substrate is fitted and the membrane installed. The designer must also include a specific QA programme within the design documentation.

10.8.1 Where membranes are used they are to have:

- Current BRANZ Appraisal or Codemark Certificate
- Minimum 15 year material warranty
- Minimum 5 year installation warranty

10.8.2 Membranes types are to be either:

- Two layer fully-bonded torch-applied reinforced modified bitumen membranes with mineral chip finish, installed in accordance with the Code of Practice for Torch-on Membrane Systems for Roofs and Decks
- Synthetic plastic sheet membranes with welded joints such as Thermoplastic Olefin (TPO), Ketone Ethylene Ester (KEE) and PVC

10.8.3 Membranes must be installed by applicators licensed or approved by the manufacturer.

10.8.4 Plywood, concrete or warm roof substrates are to be fully protected to maintain dryness and the required relative humidity levels (RH) as stipulated by the manufacturer until the membrane is laid.

10.8.5 Internal gutters, scuppers and parapets are not permitted. Membrane roofs must discharge to external spouting via a formed drip edge in accordance with the membrane manufacturer's requirements and details.

10.8.6 Contract documentation must use cross-sections primarily, with supplementary plans as necessary, to show the levels of the high and low points of the substrate at all edges and changes of plane. Work the levels back from the low point of membrane at the outlet.

10.8.7 Membrane roofs are to have:

- Minimum number of sheet joints (laid parallel the direction of roof fall only)
- Minimum pitch of 3 degrees

10.9 Membrane Roofing – Ventilation

The following requirements apply for 'cold-roof' situations:

10.9.1 Provide cross ventilation between the roof-space voids below the membrane substrate.

10.9.2 Proprietary vapour vents from the voids at 1 / 40m² of roof area (minimum vent area 400 mm²), or as per the manufacturer's system requirements.

10.9.3 Vents must be designed to ensure roof remains water-tight.

10.9.4 Any resulting reduction in 'R' value of thermal insulation is to be taken into account.

10.9.5 Where 'warm roof' systems are used – refer to manufacturer's requirements.

10.10 Translucent Roofing

Requirements for translucent sheeting are provided on the Ministry's public webpage titled *Roofing materials for school buildings* under the following filepath:

<https://education.govt.nz/school/property-and-transport/projects-and-design/design/design-standards/materials/roofing-materials/>

10.11 Sarking

The following requirements apply:

- 10.11.1 Plywood used as sarking must have its thickness determined by span, with a minimum:
- 15mm under profiled metal roofs (or as per roofing manufacturer's requirements)
 - 17.5mm as substrate for membrane roofs
 - 19mm as substrate for decks
- 10.11.2 Plywood used as sarking and other roof substrate applications such as valley boards, must be H3.2 treated.

10.12 Eaves

Eaves are required to ensure that rainwater collection points (spouting, rain water heads and downpipe spreaders) to the roof system are positioned away from the external face of the building, so that in the event of a blockage or defect, water will overflow externally and away from the building's envelope.

Other key considerations for eaves include:

- 10.12.1 For single storeyed buildings, overhanging eaves provide useful protection to windows/doors immediately underneath and help deflect rainwater away from external walls.
- 10.12.2 For multi-level buildings, they provide less benefit to lower floors, or to window or door openings in a gable end wall or high end of a mono-pitch roof where the eave overhang is some distance up from the head flashings.
- 10.12.3 They can be a means of providing solar shading to prevent direct sunlight from entering the building during summer months (refer to the Ministry's DQLS document on Thermal Comfort and Indoor Air Quality, and Lighting).
- 10.12.4 They can however compromise durability for metal wall cladding systems where they hinder/prevent natural rain-washing of cladding directly below the eave overhang to remove accumulation of airborne salts (refer also [Section 3.3](#)).

The following requirements apply:

- 10.12.5 All roof rainwater collection points (spouting, rain water heads and downpipe spreaders) must be positioned at least 600mm from the external face of the building directly below the roof, by provision of an eaves or veranda overhang.
- 10.12.6 Eaves should not be used over profiled metal walls cladding systems in situations where the cladding cannot be easily washed down through hand-held equipment from ground level.
- 10.12.7 For metal roofing in Wind Zones Very High and Extra High (NZS 3604), provide the eaves flashing as shown in E2/AS1 Figure 45.
- 10.12.8 Plywood used as soffits must be H3.2 treated and have a painted finish (oiled or stained finishes are not permitted).

10.13 Rainwater Head Overflows

10.13.1 Overflows are to be provided as an opening in the rainwater head and:

- Cross-sectional area of overflow must be 1.5 times the area required for the outlet
- Height must be set so that the overflow functions before water can enter the structure, if the downpipe becomes blocked

10.13.2 Rainwater heads are recommended at the termination of a valley or parallel gutter or in areas where high volumes of water are discharged from high level roofs (e.g. via spreaders).

10.14 Exterior Spouting

Exterior spouting of metal or PVC must be installed so that overflow provision is provided by one of the following options (refer [Figure 10-8](#) below):

10.14.1 Rear Overflow (Option 1): minimum 10mm overflow gap between the rear of the spouting and the fascia board or cladding.

10.14.2 Front Overflow (Option 2): spouting which has a front edge that is lower than the rear edge; or

10.14.3 Front Overflow Slots (Option 3): metal spouting with factory cut overflow slots in the front face (which are positioned lower than the rear edge of the spouting)

To incorporate robustness and redundancy into the design of rainwater goods:

10.14.4 Gutter capacities are to be in accordance with NZ Metal Roof and Wall Cladding Code of Practice Version 3.0 and oversized nominally.

10.14.5 Gutters must always have external brackets.

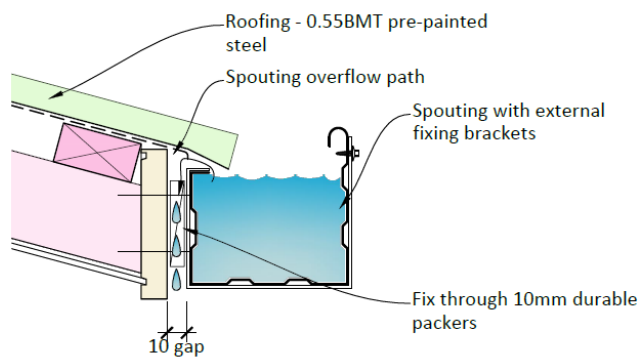

Option 1 - Rear overflow

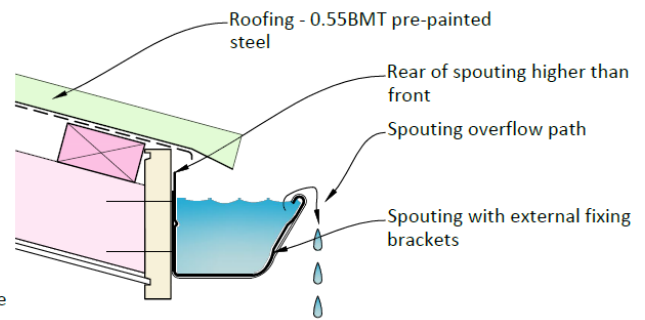

Option 2 - Front overflow

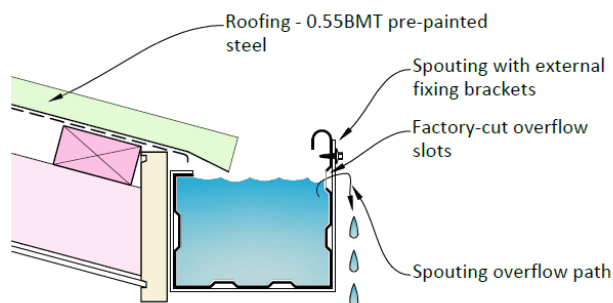

Option 3 - Front overflow slots

Figure 10-8 Spouting Overflow Options

10.15 Thermal Expansion

Metal and plastic roofing is subject to thermal expansion and contraction due to cyclical changes in local external temperatures. When thermal expansion movement is not considered and accommodated in the design of metal roofs, flashings and spouting, damage and weathertightness failure can occur due to the stresses of movement on fixings and metal sheet.

- 10.15.1 Expansion must be considered by the Designer, with specific flashing expansion details to be provided as part of the Detailed Design set. Reliance on general drawing or specification notes only is not acceptable.
- 10.15.2 Roofs, flashings and gutters with uninterrupted lengths of over 12m will require specific design to accommodate thermal expansion.
- 10.15.3 Design for thermal expansion is to be in accordance with sections 7.3 and 8.9 of the NZ Metal Roof and Wall Cladding Code of Practice Version 3.0.

10.16 Condensation and Thermal Bridging

Warm roofs are the preferred roof type for new school buildings to provide a more effective thermal envelope, help eliminate cold bridging and help avoid aggravated thermal bridging. Use of warm roof systems can also assist with meeting the Ministry's acoustics requirements for control of rain-on-roof noise (refer to the current edition of Ministry's Designing Quality Learning Spaces – Acoustics document).

- 10.16.1 Where the roof structure is steel (i.e. steel rafters/ portals and/ or steel purlins), a warm roof system must be used (see [Figure 10-9](#) below).
- 10.16.2 Where there is a risk of aggravated thermal bridging occurring in the roof space, a warm roof system must be used.
- 10.16.3 Cold roofs are permitted (but not preferred) for timber framed roof structures. If used, careful consideration must be given by the Designer to roof space ventilation and prevention of internal moisture issues in the roof space. See [Figure 10-9](#), and also refer to refer to [Sections 10.7](#) and [10.9](#).

Note: for an explanation of the causes of aggravated thermal bridging refer BRANZ Bulletin No. 572 titled: Aggravated Thermal Bridging Research.

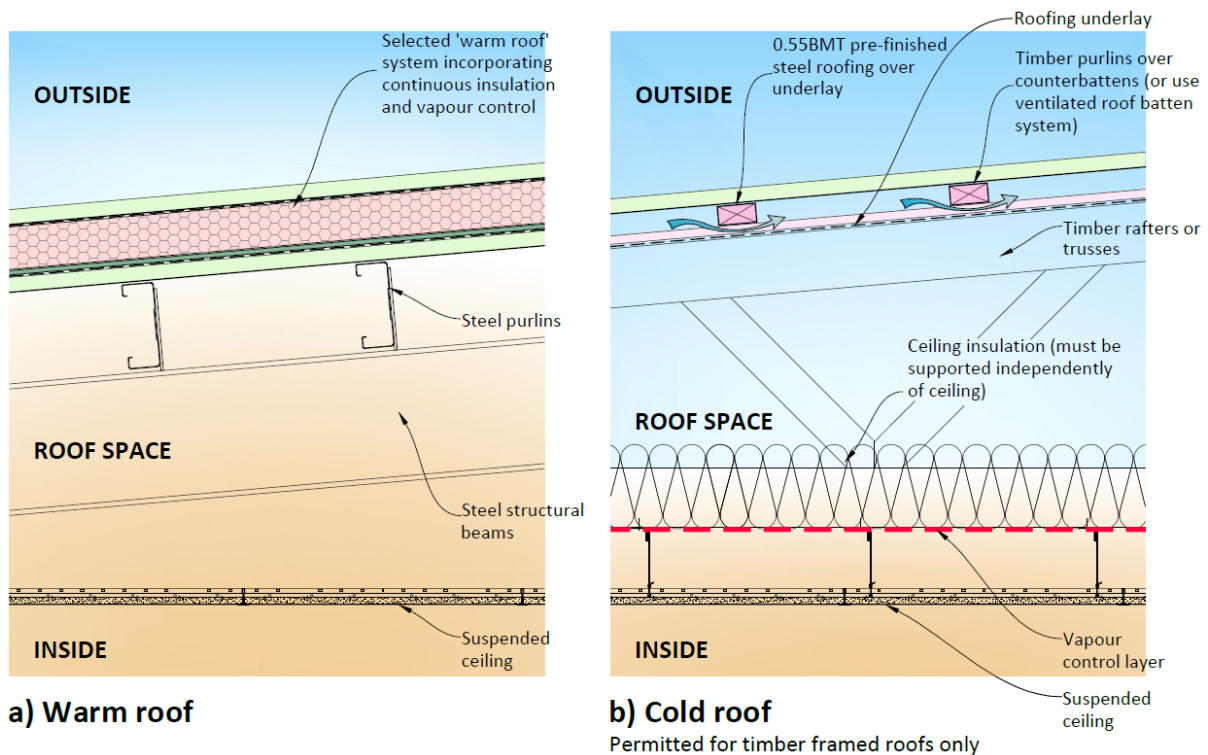

Figure 10-9 Warm Roof vs. Cold Roof Example

11 Exterior Joinery

11.1 Prohibited Items

The following materials, installations and construction systems are not to be used:

- Circular windows (including curved window elements such as arched or curved window heads)
- Curtain wall glazing exceeding 2 storeys in height
- Windows with raking jambs or sills (i.e. sills are to be horizontal and jambs vertical, but heads may be either raked or horizontal)
- Irregular shaped windows

11.2 Recessed Windows

Recessed window detailing may only be used in the following situations:

11.2.1 For metal cladding as per the NZ Metal Roof and Wall Cladding Code of Practice Version 3.0.

11.2.2 Where the recessed window details are part of a proprietary tested cladding system (with a BRANZ Appraisal, CodeMark certificate or NZS4284 test report to support compliance).

Where recessed windows are used:

11.2.3 Full 3D details showing junctions of jamb/ sill flashings and head/ jamb flashings must be provided.

11.2.4 All flashings must be mechanically secured and must not rely on sealant.

12 Balconies

12.1 Prohibited Items

The following materials, installations and construction systems are not to be used:

- Construction using cantilevered timber joists
- Cantilevered glass balustrades without a handrail
- Balconies constructed over occupied internal spaces
- Solid balustrades

12.2 Upper Level Decks / Walkways

Where concrete decks or walkways are provided at first or second floor level as an integral part of the primary upper floor slab the following requirements must be met (refer to [Figures 12-1](#) and [12-2](#) below):

12.2.1 Concrete decks must be laid, either:

- With 1:50 falls as the maximum cross-fall allowable for accessibility (however this is an alternative solution to E2/AS1 for deck membrane falls and will require Building Consent Authority and membrane supplier approval if a membrane is used), or
- To E2/AS1 falls (1:40 minimum) with a floating tile or decking system over to meet accessibility requirements and provide level access.

12.2.2 Concrete decks must be waterproofed with either:

- A trafficable welded sheet membrane
- A non-trafficable welded sheet membrane (as per [Section 10.8](#)) with a floating tile or deck system over
- A proprietary concrete waterproofing treatment (such as a penetrating spray-on system, or admixture) with suitable proof of NZBC compliance for use on concrete decks. Where such a system is used, attention must be paid to the design limitations of the system (e.g. minimum required falls, maximum crack bridging ability, maintenance requirements). Concrete deck construction must be detailed with particular attention to address cold jointing between pour elements together with mitigation of shrinkage cracking during the curing process
- A proprietary trafficable liquid applied membrane system, provided that maintenance and re-coating requirements are considered, agreed with the school and incorporated into a maintenance schedule

12.2.3 Where a proprietary floating tile or decking system is to be used in high wind pressure locations, an engineering check must be undertaken to prevent tiles or decking from becoming dislodged.

12.2.4 Where a sheet waterproofing membrane is used, full detailing of penetrations and junctions must be provided (e.g. veranda post penetrations, side fixed balustrade detailing, transitions to external stairs, membrane to building corner kick-out details etc.).

12.2.5 Where concrete nibs are required to provide cladding clearance, these are to be designed in accordance with [Section 6.5](#).

12.2.6 Provision of threshold channels to accessible thresholds at suspended concrete floors can be difficult to achieve from a structural engineering perspective. Where a threshold channel with dimensions to comply with E2/AS1 cannot be achieved for practical reasons, the architect / designer is to provide a bespoke solution for the drainage.

12.2.7 Where the deck or walkway is not fully covered in plan by a veranda roof, exterior spouting to the edge of the walkway must be provided for collection of rainwater.

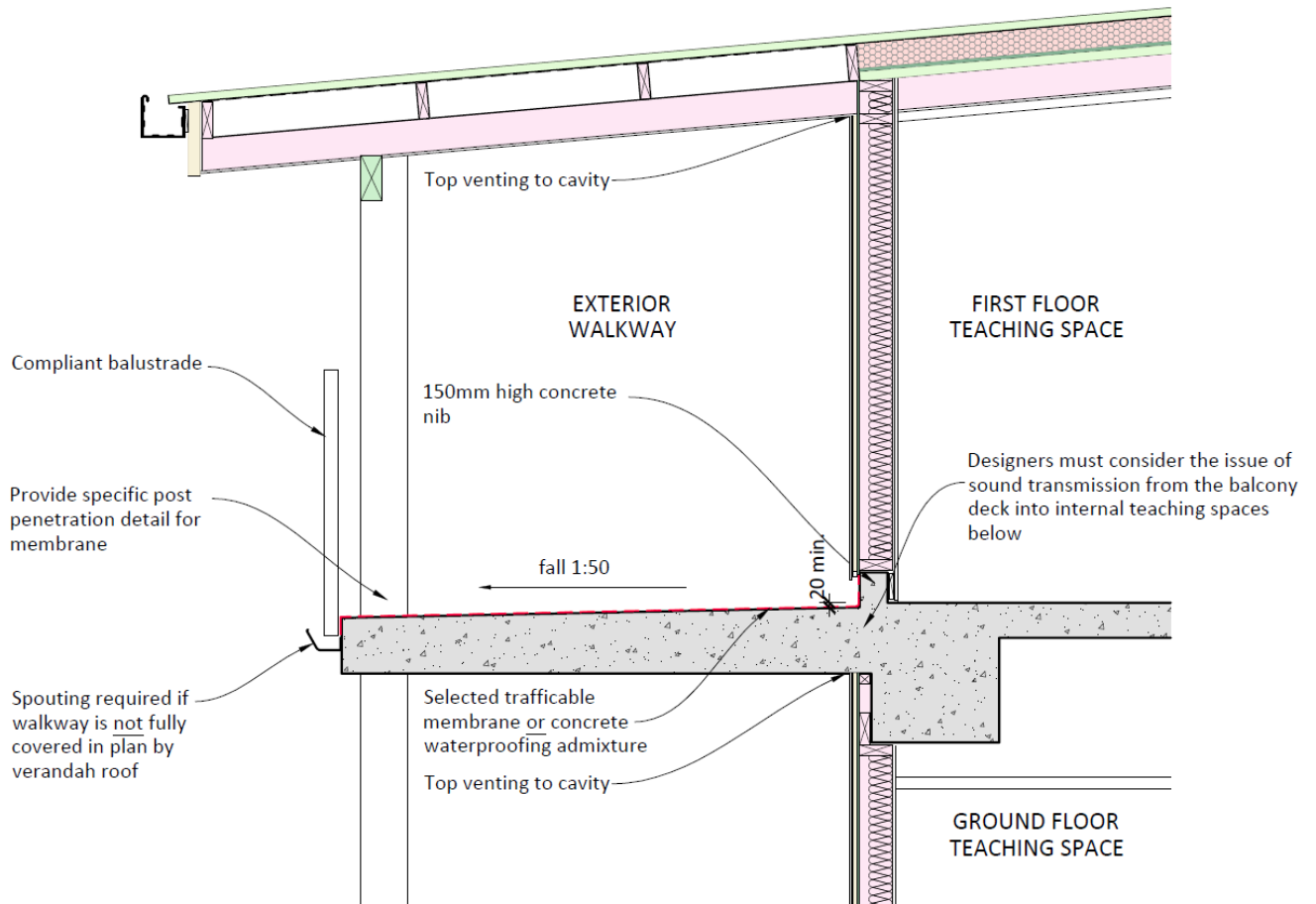

Figure 12-1 Waterproofing to Upper Decks – Trafficable Membrane or Waterproofing Admixture

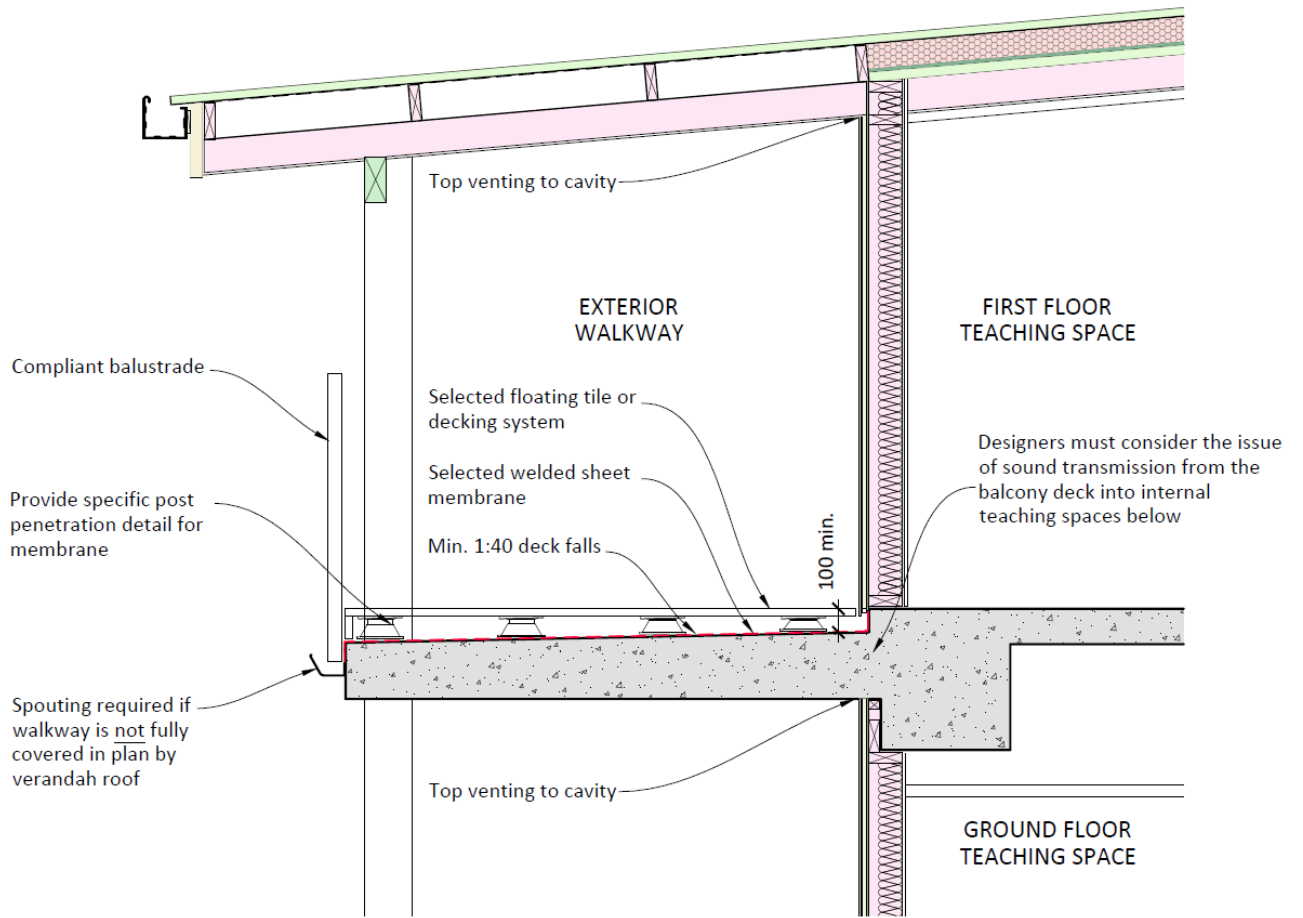

Figure 12-2 Waterproofing to Upper Decks – Non-trafficable Membrane with Floating Deck/ Tiles

Appendix A: Glossary & References

Acceptable Solution

A non-mandatory means of complying with the Building Code. If a building owner chooses to use an Acceptable Solution the BCA is required to accept that code compliance has been established.

Alternative Solution

An alternative solution is all or part of a building design that demonstrates compliance with the Building Code, but differs completely or partially from the Acceptable Solutions or Verification Methods.

Aggravated Thermal Bridging

BRANZ Bulletin issue 572 notes that this is a more severe form of thermal bridging which has been found, particularly in institutional buildings, where serious condensation occurs even though steel framing members are not in contact with the ceiling.

BRANZ

Building Research Association New Zealand.

CodeMark

CodeMark is a voluntary product certification scheme that provides an easily understood and robust way to show a building product meets the requirements of the New Zealand Building Code. A product can be a building or construction method, building design or a building material. CodeMark Certification is not challengeable by Building Consent Authorities and has a status equivalent to an Acceptable Solution for this reason.

DQLS

The Ministry's Designing Quality Learning Spaces series of documents that cover Acoustics, Thermal Comfort and Indoor Air Quality and Lighting.

DSNZ

The Ministry's Designing Schools in New Zealand - Requirements and Guidelines provides overarching design principles for school buildings.

E1/AS1

Acceptable Solution under the New Zealand Building Code covering Surface Water.

E2/AS1

Acceptable Solution under the New Zealand Building Code covering External Moisture.

Expressed Joint Cladding

These proprietary systems typically feature cladding joints that are expressed with a surface relief groove or joint that is backed with a mechanical flashing or gasket strip. The building underlay or rigid air barrier that sits behind cannot be seen.

Rigid Air Barrier

Referred to as 'Rigid Wall Underlay' in NZBC Acceptable Solution E2/AS1.

Monolithic Cladding

Exterior cladding of building is designed to be one piece showing no joints or seams. The three main types of cladding systems are texture coated fibre cement sheeting, stucco and EIFS (Exterior Insulation and Finish System).

NZBC

The New Zealand Building Code (NZBC) is established under the Building Act and is Schedule 1 of the Building Regulations 1992. It contains the functional requirements and performance criteria with which buildings must comply in their intended use. It is a performance-based code enabling building owner's choice of the means by which they meet the code.

NZ Metal Roof and Wall Cladding Code of Practice

The NZ Metal Roof and Wall Cladding Code of Practice is published by the NZ Metal Roofing Manufacturers Inc., to provide prescriptive acceptable trade practice for the fixing of metal roof and wall cladding and accessories. The latest version of the Code of Practice at the time of writing this document is v3.0, updated 01 June 2020.

Open Jointed Rain-screen Cladding

These proprietary systems typically feature the use of waterproof and protective materials that are located behind cladding systems with open joints. The waterproof membrane is visible through the joints.

SGR

The Ministry's updated Structural and Geotechnical Requirements document is scheduled for release in October 2020. This will replace the previous document titled *Structural and Geotechnical Guidelines (SGG)*.

Threshold Channels

Sometimes called Drainage Channels. Refer to [Section 6](#) of this document.

Published by the New Zealand Ministry of Education,
Education Infrastructure Service, August 2020

Ministry of Education
Matauranga House, 33 Bowen Street
PO Box 1666, Thorndon 6140
Wellington, New Zealand

www.education.govt.nz

Copyright © Ministry of Education 2020

This publication is subject to copyright. Apart from any fair dealing for the purpose of private study, research, criticism or review, or permitted under the Copyright Act, no part may be reproduced without the permission of the Ministry of Education, New Zealand.

New Zealand Government